

Creation & Service

"We always do our best for your satisfaction"

CONTENTS



House Keeping Equipment

002 - 037



F & B Service Trolleys

038 - 051



Banquet Furniture & Carts

052 - 077



Buffet Station & Display Table

078 - 105



Kitchen & Catering Equipment

106 - 119



Buffet Wares

120 - 149



Creation & Service

House Keeping Equipment

HOTEL SPECIALTY



CONTENTS

House Keeping Equipment

004 - 005
Luggage Carts

008 - 009
Stanchion Posts and Belts

014 - 015
Motorized Room Maid Trolley

018
Laundry Trolleys and Coat Hangers

020 - 021
Shelf

023
Luggage Stands

025
Sign Stand and Ashtray

027
Waste Basket

030 - 036
Guest Room Supplies

006 - 007
Office Furniture

010 - 013
Room Maid Trolleys

016 - 017
Canvas Trolleys

019
Laundry Trolleys

022
Mini Bars and Extra Beds

024
Sign Stand

026
Ashtray

028
Cleaning Supplier Series



DCS 24D2216
Crown Luggage Cart
(L)1130 x (W)615 x (H)2000
Material: Titanium gold, Red Carpet



DCS 24D2218
Crown Luggage Cart
(L)1140 x (W)670 x (H)1900
Material: Gold, Black Carpet



DCS 24D2214
Crown Luggage Cart
(L)1130 x (W)615 x (H)2000
Material: Titanium gold, Red Carpet



DCS 24D2217
Modern Luggage Cart
(L)1130 x (W)615 x (H)2000
Material: Stainless, Gray Carpet



DCS 24D2219
Luggage hanger Cart
(L)1200 x (W)650 x (H)1830
Material: Stainless, Black Carpet



DCS 24D2219-004
Modern Luggage Cart
(L)1135 x (W)670 x (H)1840
Material: Stainless(rosegold), Black Carpet



DCS 24D2220
Crown Luggage Cart
(L)1140 x (W)580 x (H)1900
Material: Rose gold, Red Carpet





handle cover

DCS 24D2213 / DCS 24D2203
Luggage Cart

(L)1130 x (W)615 x (H)910
Material: Titanium gold, Red Carpet
Material: Stainless, Gray Carpet



DCS 24D2204
Luggage Cart

(L)1140 x (W)670 x (H)970
Material: tainless, Black Carpet



DCS 24D2205
Luggage Cart

(L)1200 x (W)650 x (H)970
Material: Stainless, Black Carpet



DCS 24D1116-042
Luggage Cart

(L)972 x (W)650 x (H)947



DCS 24D1116
Airport Cart

(L)960 x (W)675 x (H)1030



DCS 24D1116-041
Airport Cart (small)

(L)630 x (W)530 x (H)985



DCS 24D1112-01
Bell Man Hand Cart

(L)600 x (W)530 x (H)1220
Material: Brass, Red Carpet



DCS 24D1112-02
Bell Man Hand Cart

(L)500 x (W)400 x (H)1200
Material: Stainless, Black Carpet



DCS 24D1113
Bell Man Hand Cart

(L)850 x (W)550 x (H)1200
Material: Stainless, Gray Carpet



DCS 24D0001-005
Umbrella Dryer (Big)
(L)940 x(W)300 x (H)880



DCS 24D0001-006
Umbrella Dryer (Small)
(L)630 x(W)330 x (H)840



DCS 24D0001-013
Umbrella Dryer (Big)
(L)830 x(W)290 x (H)860



DCS 24D0001-010
Umbrella Dryer (Small)
(L)500 x(W)300 x (H)810



DCS 24D5502-004
Umbrella Dryer (Big)
(L)923 x(W)300 x (H)823



DCS 24D5502-005
Umbrella Dryer (Small)
(L)585 x(W)260 x (H)823



DCS 24D5502-006
Umbrella Dryer (Big)
(L)960 x(W)300 x (H)870



DCS 24D5502-007
Umbrella Dryer (Small)
(L)500 x(W)300 x (H)870



DCS 24D5502-008
Umbrella Dry Holder
(L)400 x(W)400 x (H)870



DCS 24D5502-1
우산꽂이
(L)350 x (W)280 x(H)685



DCS 24D5504
우산 보관대
(L)825 x (W)465 x (H)900



DCS 24D5505
우산 보관대
(L)760 x (W)500 x (H)1000

DCS 24D5502-2
우산꽂이
(L)350 x (W)280 x(H)685



DCS 24D3301
Safety Deposit Box (16Box)
(L)730 x (W)400 x (H)620



DCS 24D3321-16
Safety Deposit Box (16Box)
(L)800 x (W)450 x (H)1050



DCS 24D3321-22
Safety Deposit Box (22Box)
(L)800 x (W)450 x (H)1480

DCS 24D3302
Safety Deposit Box (21Box)
(L)730 x (W)400 x (H)850

DCS 24D3303
Safety Deposit Box (28Box)
(L)730 x (W)400 x (H)1200



DCS 23D8802-001
디지털금고
(W)325 x (H)115 x (D)325
Color: Black
Material: 본체 철판위 분체도장
Power: DC-AA 배터리 4개입
Weight: 8.5kg 도어: 5
본체: 2 Steel plate
구성품: 금고 본체, 마스터 키
AA배터리 4개
DC방전용 오픈케이스 1개



DCS 23D8802-002
디지털금고
(W)400 x (H)125 x (D)350
Color: Black
Material: 본체 철판위 분체도장
Power: DC-AA 배터리 4개입
Weight: 11kg 도어: 5
본체: 2 Steel plate
구성품: 금고 본체, 마스터 키
AA배터리 4개
DC방전용 오픈케이스 1개



DCS 23D8801-BK1
디지털금고
(W)435 x (H)200 x (D)365
Color: Black
Material: 본체 철판위 분체도장
Power: DC-AA 배터리 4개입
Weight: 12.6kg 도어: 5
본체: 2 Steel plate
구성품: 금고 본체, 마스터 키,
AA배터리 4개
DC방전용 오픈케이스 1개



DCS 51D2221-315
Roll Band Partition
(Φ)320 x 985 (Band : 2M)
Material: Titanium



DCS 51D2222-119
Roll Band Partition
(Φ)360 x 900 (Band : 2M)
Material: Stainless



DCS 51D2222-117
Roll Band Partition
(Φ)280 x (H)1000



DCS 51D2222-118
Roll Band Partition (2layer belt)
(Φ)320 x (H)915



DCS 51D2222-1113
Roll Band Partition
(Φ)360 x (H)895

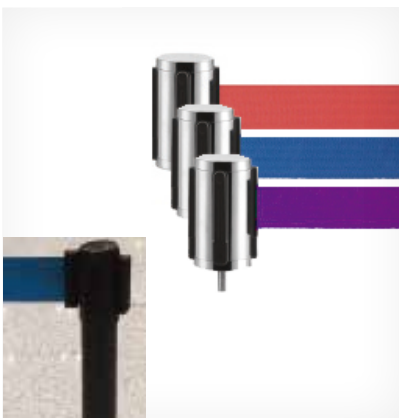

DCS 51D2222
Belt Head
(L)920



DCS 51D2222-120
Roll Band Partition Sign Board
(L)215 x (W)325



DCS 51D2222-121
Roll Band Partition Sign Board
(L)220 x (W)305



DCS 51D2211
Partition Base
(Φ)320 x 1000 (Rope : 1200)Material:
Titanium gold



DCS 51D2211-313
Partition Base
(Φ)320 x 1000
Material: Titanium



DCS 51D2211-314
Partition Base
(Φ)280 x 1000
Material: Titanium



DCS 51D2211-111
Partition Base
(Φ)360 x 930
Material: Stainless



DCS 51D2211-112
Partition Base
(Φ)320 x 987
Material: Stainless



DCS 51D2211-311
Partition Base
(Φ)320 x 935
Material: Titanium

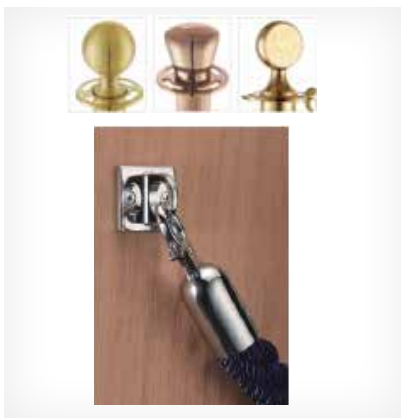

DCS 51D2203-322
Wall Hooks





DCS 23D1101
Room Maid Trolley
(L)1340 x (W)460 x (H)1180



DCS DCS23D2220
Room Maid Trolley
(L)1440 x (W)540 x (H)1370



DCS 23D2221-01
Housekeeping Cart
(L)1560 x (W)580 x (H)1230
Material: Plastic Frame (Black Color)



DCS 23D1103
Room Maid Trolley
(L)1000 x (W)450 x (H)1160



DCS 23D1104
Room Maid Trolley
(L)930 x (W)460 x (H)1110



DCS 23D2226
Housekeeping Cart
(L)1060 x (W)550 x (H)1200
Material: Steel Plate, Aluminium Plate



DCS 23D2215-S01
Housekeeping Cart
(L)1050 x (W)450 x (H)1160
Material: Steel Plate, 분체도장



DCS 23D2214
Room Maid Trolley
(L)1420 x (W)460 x (H)1180



DCS 23D2224
Housekeeping Cart
(L)1340 x (W)550 x (H)1370
Material: Steel Plate, 분체도장



DCS 23D2211
Room Maid Trolley
(L)1440 x (W)540 x (H)1370



DCS 23D2221-003
Plastic Maid cart / 전면 오픈형
(L)1558 x (W)549 x (H)1216



DCS 23D2221-002
Plastic Maid cart / 전면 오픈형
(L)1205 x (W)549 x (H)1216



DCS 23D2221-008
Plastic Maid cart / 전면 도어형
(L)1205 x (W)549 x (H)1216



DCS 23D2223
Housekeeping Cart
(L)1260 x (W)530 x (H)1230
(L)860 x (W)530 x (H)1230



DCS 23D2223-005
Room Maid Cart / Rattan
(L)600 x (W)453 x (H)1140



DCS 23D222
Room Maid cart / 러게지형
Amenity Caddy Options
H.D Nylon



DCS 23D2215-001
Room Maid cart / 캐리어형
(L)560 x (W)522 x (H)1060



DCS 23D2215-004
Room Maid cart / 캐리어형
(L)600 x (W)540 x (H)860



DCS 23D2215-005
Room Maid Cart / 러게지형
(L)560 x (W)522 x (H)1060



DCS TY-1-3032

Dora Maid Trolley

(L)910 x (W)450 x (H)1115

Material: Combination of stainless steel 304 & mild steel

Features: 2 units detachable canvas bags on top.

Platform with polyurethane corner guard.

Heavy duty wheels.



DCS TY-1-3029

Cubic Maid Trolley

(L)1100 x (W)500 x (H)1250

Material: Combination of stainless steel 304 & mild steel

Features: Flip door top compartment with gas lift.

Heavy duty wheels.



DCS TY-1-3031

Mini Maid Trolley

(L)890 x (W)600 x (H)1250

Material: Combination of stainless steel 304 & mild steel

Features: Flip door top compartment.

Detachable canvas.

Platform with polyurethane bumper edging.

Heavy duty wheels.



DCS TY-1-3028

Minion Maid Trolley

(L)1130 x (W)520 x (H)1185

Material: Combination of stainless steel 304 & mild steel

Features: Flip door top compartment with gas lift.

Heavy duty wheels.





전·후진 레버 비상스위치
전원스위치
속도조절기
인디케이트

전동카트 제어 시스템



150Kg까지 적재 가능한 강력한 힘으로 경사에서도 힘들이지 않고 안전감있게 사용할 수 있습니다.

Product Features

모델명	DCS 23D1101016
사이즈	1450mm x 500mm x H1260mm
모터	24V 180W
배터리 용량	리튬 배터리 20AH
충전 소요시간	0~100%까지 3시간(고속충전)
최대/최소 속도	4KM/H
무게	55kg
최대허용무게	150kg

DCS 23D1101016 메인 트롤리 프레임(8인치 TPR 휠) + 전동카트 제어 시스템 기능:

1. 양방향 및 안전한 제어 운영 시스템(핸드 로터리 컨트롤러에는 브러시 전자기 브레이크 모터 24V 180W가 장착되어 있습니다).
2. 잠금 보호, 전자기 브레이크 작동, 스위치를 길게 눌러 차량 잠금을 해제합니다. 하단레버로 전동 및 무전동 구동 변환이 가능.
3. 느린 속도에서 설정 속도(4KM/H), 경사 균일 속도, 주차 브레이크 가능.
4. 전원 디스플레이 작동, 골드 컬렉션 전압 충전 사용, 배터리는 완전 충전 시 과부하 보호 기능을 갖추고 있음, 전동카트 작동 시 12시간 (지속 주행 2~3시간) 동안 사용.
5. 속도를 제어할 수 있습니다, 비상 정지 전원을 채택하여 안전운전 가능.
6. 고장 알람, 고장 램프를 통해 고장 유형 표시합니다.

전동카트 플랫폼을 활용한 다양한 디자인 제품 제작 가능



메인 트롤리 프레임(8인치 TPR 휠) + 전동카트 제어 시스템



DCS 23D3301
Canvas Trolley (A)
(L)650 x (W)500 x (H)750
Material: Stainless Steel Pipe, Canvas



DCS 23D3308
Canvas Trolley (L)
(L)950 x (W)650 x (H)870



DCS 23D3302
Canvas Trolley (B)
(L)750 x (W)550 x (H)750
Material: Stainless Steel Pipe, Canvas



DCS 23D3301-014
Canvas Trolley
(L)750 x (W)550 x (H)750



DCS 23D3301-016
Canvas Trolley
(L)750 x (W)550 x (H)850



DCS 23D3305-005
Canvas Trolley
(L)920 x (W)560 x (H)910



DCS 23D3304-01
Canvas Trolley
(L)900 x (W)650 x (H)850



DCS 23D3304-02E
Canvas Trolley (B)
(L)900 x (W)650 x (H)850
Material: Stainless Steel Pipe, Canvas



DCS 23D3304-03F
Canvas Trolley
(L)1000 x (W)700 x (H)900



DCS 23D3303-002
Canvas Trolley H-Type
(L)800 x (W)500 x (H)750
Material: Stainless Steel Pipe, Canvas



DCS JWD-CC300
Foldable Linen Cart
300L : (L)895 x (W)660 x (H)860



DCS JWD-CC150
Foldable Linen Cart
150L : (L)660 x (W)495 x (H)860



DCS 23D3306-01
Canvas Trolley & cover
(L)640 x (W)485 x (H)1070



DCS 23D3306-03
Canvas Trolley (3구)
(L)990 x (W)620 x (H)915



DCS 23D3310
Canvas Trolley
(Φ)630 x 810mm



DCS 23D3301-001
캔바스트로리 자루 (A형)
아이보리 방수커버
(L)600 x (W)450 x (H)600



DCS 23D3302-001
캔바스트로리 자루 (B형)
아이보리 방수커버
(L)700 x (W)500 x (H)600



DCS 23D3301-015
캔바스트로리 자루 (A형)
블랙 방수커버 (벨크로)
(L)700 x (W)500 x (H)600



DCS 23D3308-001
캔바스트로리 자루 (A형)
브라운 방수커버
(L)900 x (W)600 x (H)680



DCS 23D3301-100
룸메이스트로리 자루 (대)
아이보리 방수커버
(L)400 x (W)300 x (H)720



DCS 23D3301-200
룸메이스트로리 자루 (소)
아이보리 방수커버
(L)400 x (W)300 x (H)455



DCS 23D5501
Linen Trolley
(L)1100 x (W)600 x (H)1300
Material: Stainless Steel Pipe & Plate



DCS 23D5502
Linen Trolley
(L)1100 x (W)485 x (H)1570
Material: Stainless Steel Pipe & Plate



DCS 23D4405
Laundry Trolley
(L)1300 x (W)600 x (H)1700
Material: Stainless Steel Pipe & Steel mesh & Plate



DCS 23D5515
Linen Hanger Cart (접이식 선반)
(L)900 x (W)550 x (H)1800
Material: Stainless Steel Pipe & Plate



DCS 23D5514
Linen Hanger Trolley (접이식 선반)
(L)1160 x (W)590 x (H)1800



DCS 23D5511
Linen Hanger Trolley
(L)900 x (W)600 x (H)1800
Material: Stainless Steel Pipe & Plate



DCS 23D5513
Linen Hanger Trolley
(L)1200 x (W)550 x (H)1700



DCS 23D5512
Linen Hanger Trolley
(L)920 x (W)620 x (H)1650
Material: Stainless Steel Pipe & Plate & Canvas



DCS 23D5520
Coat Hanger
(L)1500 x (W)600 x (H)1700



DCS 23D5522
Coat Hanger
(L)1500 x (W)600 x (H)2000



DCS 23D5524
Coat Hanger
(L)1500 x (W)600 x (H)2000



DCS 23D5523
Coat Hanger
(L)1300 x (W)650 x (H)1815



DCS 23D4403-003
Laundry Trolley

(L)1100 x (W)600 x (H)1300/1500
Material: Stainless Pipe & Plate



DCS 23D4404-009
Laundry Trolley

(L)1100 x (W)600 x (H)1300/1500 mm
Material: Stainless Pipe & Plate



DCS 23D4403-005
Laundry Trolley

(L)900 x (W)750 x (H)1600 mm
Material: Stainless Pipe & Plate



DCS 23D4403-011
Laundry Trolley (Lock)

(L)1100 x (W)600 x (H)1300/1500
Material: Steel Pipe & powder coating



DCS 23D5504-A
Laundry Trolley-A

(L)1200 x (W)850 x (H)1750
Material: Stainless Pipe & Plate



DCS 23D5504-B
Laundry Trolley-B

(L)1200 x (W)850 x (H)1770
Material: Stainless Pipe & Plate



DCS 42D5510-040
Laundry Trolley

(세탁 작업용 테이블)
(L)2000 x (W)1000 x (H)700
Material: Stainless Plate & Pipe



DCS 23D4402-T01
Laundry Trolley

(L)1500 x (W)1200 x (H)690
Material: Stainless Pipe & Net or Punched Plate



DCS 23D4402
Laundry Trolley

(L)1120 x (W)600 x (H)850
Material: Stainless Pipe & Net or Punched Plate



DCS 23D4401
Laundry Trolley

(L)880 x (W)500 x (H)850
Material: Stainless Pipe & Net or Punched Plate



DCS 42D4430
연결형

DCS 42D4430
독립형

DxWxH	1800 (4단)	2100 (4단)	색 상	
450	900	450x900x1800	450x900x2100	아이보리
	1200	450x1200x1800	450x1200x2100	아이보리
	1500	450x1500x1800	450x1500x2100	아이보리
	1800	450x1800x1800	450x1800x2100	아이보리
600	900	600x900x1800	600x900x2100	아이보리
	1200	600x1200x1800	600x1200x2100	아이보리
	1500	600x1500x1800	600x1500x2100	아이보리
	1800	600x1800x1800	600x1800x2100	아이보리



S/S Shelving / Chromed Shelving



Art.No	Size: L x W x H	Art.No	Size: L x W x H
SN241871	610x455x1800	SN482171	1220x530x1800
SN301871	760x455x1800	SN542171	370x530x1800
SN361871	910x455x1800	SN602171	1525x530x1800
SN421871	1060x455x1800	SN722171	1825x530x1800
SN481871	1220x455x1800	SN242471	610x610x1800
SN541871	1370x455x1800	SN302471	760x610x1800
SN601871	1525x455x1800	SN362471	910x610x1800
SN721871	1825x455x1800	SN422471	1060x610x1800
SN242171	610x530x1800	SN482471	1220x610x1800
SN302171	760x530x1800	SN542471	1370x610x1800
SN362171	910x530x1800	SN602471	1525x610x1800
SN422171	1060x530x1800	SN722471	1825x610x1800

1800mm Height

Epoxy Wire Shelving



Wine Storage Rack



Caster



Art.No	JW-5S	JW-5SC
Name	5" Universal Casters	5" Universal Casters With Brake
Size	127mm / 5"	127mm / 5"

Winshelvings

Easy to adjust and install

It's easy to adjust and install. With different sizes (3 heights, 4 widths, 6 lengths), space utilization is highly increased. The nets can be adjusted up or down by 100 millimeters with disassembly. Shelves can be built to U-shape units with corner connectors.

Absolutely firm, durable and stable

Made from a steel core and polypropylene. Inner steel provides high intensity and durability. Exterior PP is anti-corrosion and break-resistant. Post connectors provide exceptional stabilization.

Never rust

Can be used anywhere, no matter moist or dry, weldless, never rust. Resists corrosion by brine or marine air. Suitable for coolers and freezers, available under -38°C.



Winshelvings

Multi environments use
From -38°C to 88°C

Stationary Units

Mobile Units

High-Density Units

NSF



High Density Mobile Shelving Storage System

Maximum storage capacity can be achieved by forming a storage channel in all available space. The mobile shelving storage system is composed of the basic units on the raised track, with high density movable shelves in the middle. Tracks are easy to be installed without drilling or bonding.

40%
Increase Storage Capacity

A: Stationary Units
B: Mobile Units
C: Track
D: Active Aisle



The track conveniently connects to the bottom of stationary shelving, no bolts or drilling into the floor are required. Using the connecting bolt to fasten the track.



Raised track provides a smooth surface for mobile units. It ensures dirt will not get trapped, and is easy to clean. Shelves unit with heavy weight lands can roll smoothly on the track.



Grooved casters roll easily on raised track, which can be used on any surface. The caster with a bumper can provide protection.

Dunnage Stand

Recommended for 1370mm or longer. Recommended for weight bearing capacity to 450kg on the bottom shelf.



Winshelvings

1600 mm
Vented Starter Add-on Units

Width	Length	910 mm	1060 mm	1220 mm	1370 mm	1525 mm	1825 mm
355 mm	14"	Art.No. PSA361464 Weight/Cube 22.28/0.076	Art.No. PSA421464 25.03/0.092	Art.No. PSA481464 27.79/0.096	Art.No. PSA541464 31.19/0.112	Art.No. PSA601464 34.64/0.114	Art.No. PSA721464 38.97/0.143
	18"	Art.No. PSA361864 Weight/Cube 24.97/0.084	Art.No. PSA421864 28.14/0.100	Art.No. PSA481864 31.43/0.106	Art.No. PSA541864 35.25/0.122	Art.No. PSA601864 39.01/0.127	Art.No. PSA721864 44.69/0.154
455 mm	21"	Art.No. PSA362164 Weight/Cube 26.66/0.098	Art.No. PSA422164 29.93/0.114	Art.No. PSA482164 33.38/0.128	Art.No. PSA542164 37.30/0.134	Art.No. PSA602164 40.98/0.145	Art.No. PSA722164 47.05/0.172
	24"	Art.No. PSA362464 Weight/Cube 27.28/0.103	Art.No. PSA422464 31.18/0.113	Art.No. PSA482464 34.28/0.137	Art.No. PSA542464 38.80/0.148	Art.No. PSA602464 43.20/0.156	Art.No. PSA722464 48.96/0.189

Winshelvings Parts

Casters

It is suitable for all storage areas, especially for refrigerated rooms and wet areas. It consists of highly durable, non-corroded plastic and 127mm non-marking thermoplastic rubber universal wheel.

Art.No.	PSL	PS
Dimension Size	With Brake	Without Brake
	127mm, 9"	127mm, 9"



Corner Connector Set

Corner connectors can be used to build corner units or U-shaped units. A set of corner connectors is needed for each shelf. When corner connectors are used, weight bearing capacity will be decreased to 150kg per shelf. Recommended for travelers equal to or shorter than 1220mm.



Tool for assembling removing corner connector.

PCC Including low about

Shelf Plates

The material of shelf plates is polypropylene. The design of shelf plates is solid or vented.

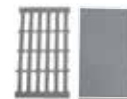

Post Connectors

Post connectors hold two posts together and define the width of the unit. Be made of polypropylene, provide exceptional cross stabilization.

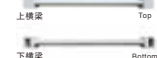



DCS 23D1131
Mini Bar Restocking Cart
(L)940 x (W)480 x (H)1200
Material: Steel Plate with Powder Coating



DCS 23D1132
Mini Bar Restocking Cart
(L)1000 x (W)560 x (H)1160
Material: Steel Plate with Powder Coating



DCS 23D1132-002
Mini Bar Restocking Cart Front Door with Lock
(L)600 x (W)450 x (H)1200
Material: Material: Steel Frame, HPM plate



DCS 23D1132-005
Mini Bar Restocking Cart Front Open, Top Drawer
(L)900/1050 x (W)560 x (H)1330
Material: Stainlee top/ steel body with black Powder coating



DCS 23D9903
Extra Bed
(L)1975 x (W)1045 x (H)660



DCS 23D9904-B
Folding Baby Crib
(L)1100 x (W)630 x (H)930



DCS 23D9904-N
Folding Baby Crib
(L)1100 x (W)630 x (H)930



DCS 23D7710
Folding Luggage Stand
(L)500 x (W)480 x (H)500~650



DCS 23D7711
Folding Luggage Stand
(L)500 x (W)480 x (H)500



DCS 23D7720
Folding Luggage Stand
(L)610 x (W)520 x (H)650



DCS 23D7741-0021
Luggage Wooden Rack
(L)700 x (W)555 x (H)500



DCS 23D7744
Luggage Wooden Rack
(L)550 x (W)430 x (H)550



DCS 23D7713
Luggage Rack
(L)650 x (W)600 x (H)600



DCS 23D7722-003
Luggage Rack
(L)670 x (W)535 x (H)520~690



HOUSE KEEPING EQUIPMENT



DCS 51D1122
Sign Stand
A1, A2, A3



DCS51D1129-A3
Mene Stand
A3
Material: 미송엔틱



DCS 51D1131-E
Sign Stand
(L)740 x (W)500 x (H)1550 (A2 420*594)



DCS 51D1132-C
Sign Stand
(L)740 x (W)500 x (H)1550 (A2 420*594)



DCS 51D1132-A
Sign Stand
(L)740 x (W)500 x (H)1550 (A2 420*594)



DCS 51D1131
Sign Stand
(L)950 x (W)700 x (H)1660



DCS 51D1131-A
Sign Stand
(L)570 x (W)650 x (H)1450



DCS 51D1123-A31
Sign Stand
(L)290 x (W)290 x (H)1100~1650



DCS TR7114
Sign Stand
(L)660 x (W)279 x (H)305



DCS HMD7701-700
Sign Stand
(L)580 x (W)475 x (H)590 A3



DCS HMD77017HL
DCS HMD77017HS
Sign Stand
(L)300 x (W)280 x (H)600 mm (대)
(L)240 x (W)260 x (H)580 mm (소)



DCS 50D1173-232
DCS 50D1173-262
Ashtray
(L)400 x (W)260 x (H)1040



DCS 50D1173-233
DCS 50D1173-234
Ashtray
(L)300 x (W)250 x (H)990
(L)480 x (W)250 x (H)990



DCS 50D1173-292
Ashtray
Φ300x (H)1040



DCS 50D1173-129U
Ashtray
(L)285 x (W)285 x (H)1170



DCS 50D1173-129A
Ashtray
Φ225x (H)1100



DCS 50D1173-129B
Ashtray
Φ225x (H)1100



DCS X2D1120-003
DCS X2D1121-017
 Square Ashtray
 (L)305 x (W)305 x (H)625



DCS 50D3302/50D3303
 Round Ashtray (S/S)
 (L)Φ300, (M)Φ245, (S)Φ220 x (H)670



DCS X7DAA01
 Marble Ashtray
 (L)250 x (W)250 x (H)690



DCS 50D1171
 Marble Ashtray
 (L)250 x (W)250 x (H)700



DCS 50D2281/50D2282
 Oblong Ashtray (coating)
 (L)250 x (W)350 x (H)700



DCS X1D110U (블랙골드/실버)
 Round Dust Bin
 (Φ)380 x 800
 Material: Stainless Plate



DCS X1D110C (스텐/블랙)
 Round Dust Bin
 Φ250x(H)670
 Φ305x(H)645
 Φ380x(H)765



DCS 50D2283
 Oblong Dust bin with cover
 (L)250 x (W)350 x (H)700



DCS 05DFF01

Pedal Bin Tray

(L)230 X (W)228 X (H)300 (5L)
 COLOR: Silver - Matt / Rose Gold
 Champagne Gold / Black Gold

DCS 20DFF01

Pedal Bin Tray

(L)328 X (W)330 X (H)478 (25L)
 COLOR: Silver - Matt / Rose Gold
 Champagne Gold / Black Gold

DCS 30DFF01

Pedal Bin Tray

(L)328 X (W)330 X (H)700 (30L)
 COLOR: Silver - Matt / Rose Gold
 Champagne Gold / Black Gold



DCS X2D0050-03 DCS X2D0050-12

Round Dust Bin with Rotary Bin

Φ230 x 320
 Color: 03 silver / 12 Black



DCS X7D4400

Mesh Round waste basket

(Φ) 260 x (H)295 mm
 Color: Silver, Grey, Black, Beige



DSC X7D5500

Mesh Square waste basket

225 x 225 x (H) 300
 Color: Silver, Grey, Black, Beige



DCS X4D5500

Round Dust Bin

(Φ)220 x (H)280
 Color: Silver / Red + silver / Coffee + silver / Black + silver Red peach wood
 + silver / Red peach wood + silver Silver+ leather / Silver+ leather /
 Beige + silver Brown + silver / Black + silver / Wine red + silver



DCS X4D55B0

Oval Round Dust Bin

(L)260 x (W)195 x (H)265
 Color: Silver / Red + silver / Coffee + silver / Black + silver Red peach wood
 + silver / Red peach wood + silver Silver+ leather / Silver+ leather /
 Beige + silver Brown + silver / Black + silver / Wine red + silver



DCS 50D1110-BK0
Cleaning Cart
(L)1240 x (W)550 x (H)1000



DCS JWD-CCED
Cleaning Cart
(L)1212 x (W)575 x (H)1320



DCS 52D2230
마포 탈수기 SZC-01
(L)925 x (W)470 x (H)940



DCS 52D2200
마포 탈수기 SZC-02
(L)590 x (W)470 x (H)965



DCS 10D2210
토르 대용량 사각컨테이너
(L)724 x (W)594 x (H)927



DCS 10D1120
다용도 원형 컨테이너
(L)560 x (W)485 x (H)582



DCS 16D1120
컨테이너 덮개
(L)545 x (W)507 x (H)55



DCS 18D1130
원형 돌리
(Φ) 460 x 160



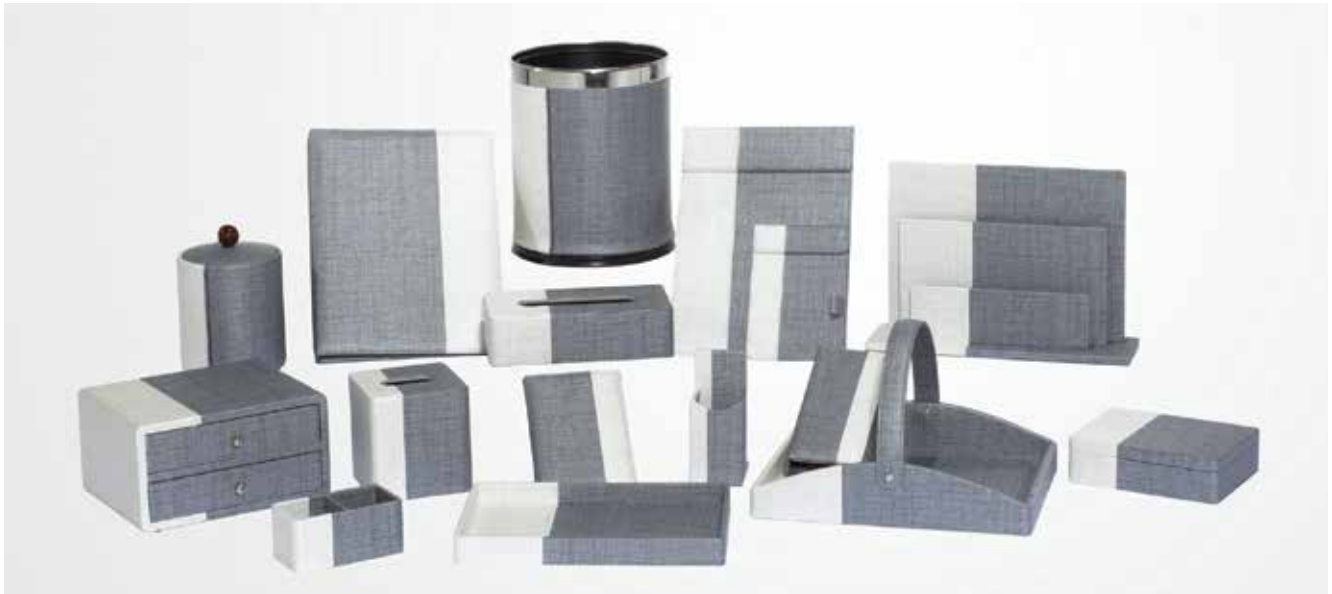

Tea Box
(L)140 x (W)75 x (H)65



Square Tissue Box
(L)125x (W)125 x (H)135



Rectangle Tissue Box
(L)240 x (W)125 x (H)65



Meeting Pad
(L)240 x (W)340 x (H)65



Magazine Rack
(L)355 x (W)100 x (H)240



Service Directory Folder
(L)250 x (W)330 x (H)40



Service Directory Folder
(L)250 x (W)330 x (H)40



**Remote Control Cover
& Remote Control Rack**
95 x (W)220 x (H)45

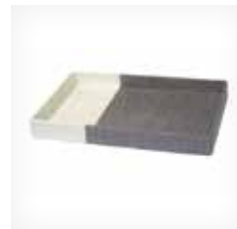

Tray
(L)320 x (W)210 x (H)40



Ice Bucket (1.0L)



Dustbin
(L)230 x (W)230 x (H)270



Cashier Folder
(L)125 x (W)210



Jewelry Box
(L)220 x (W)150 x (H)55



Shoes Basket
(L)340 x (W)270 x (H)40/80



Consumable Box
(L)250 x (W)205 x (H)130



Rectangle Tissue Box
(L)240 x (W)125 x (H)65



Service Directory Folder
(L)250 x (W)330 x (H)40



Square Tissue Box
(L)125 x (W)125 x (H)135



Tray
(L)320 x (W)210 x (H)60



Ice Bucket (1.0L)



Alarm Clock
(L)100 x (W)48 x (H)135



Notepad Holder
(L)130 X (W)195 X (H)40



Remote Control Rack
(L)65 X (W)85 X (H)155



Cashier Folder
(L)125 X (W)210 X (H)20



Magazine Rack
(L)230 x (W)100 x (H)320



Dustbin
(L)230 x (W)230 x (H)270



Meeting Pad
(L)240 x (W)340 x (H)50



Tea Box
(L)90 x (W)70 x (H)50



Remote Control Cover
(L)90 x (W)220 x (H)40



Stationery Case
(L)250 x (W)120 x (H)30



Square Tissue Box
(L)125 x (W)125 x (H)135



Rectangle Tissue Box
(L)240 x (W)130 x (H)75



Notepad Folder
(L)130 x (W)195 / 40



Shoes Basket
(L)400 x (W)300 x (H)80



Consumable Box
(L)285 x (W)225 x (H)90



Alarm Clock
(L)100 x (W)48 x (H)135



Service Directory Folder
(L)250 x (W)330 x (H)40



Cashier Folder
(L)125 x (W)240 x (H)25



Remote Control Cover
(L)125 x (W)240 x (H)25



Tray
(L)400 x (W)300 x (H)45



Towel Tray
(L)210 x (W)118 x (H)15



Tea Box
(L)80 x (W)80 x (H)80



Soap Tray
(L)100 x (W)100 x (H)20



Environmental Card
(L)115 x (H)98



Rectangle Tissue Box

(L)245 x (W)125 x (H)75



Square Tissue Box

(L)130 x (W)130 x (H)130



Soap Dispenser

(L)90 x (W)70 x (H)120



Tea Box

(L)70 x (W)70 x (H)95



Consumable Box

(L)290 x (W)210 x (H)75



Vase

(L)40 x (W)40 x (H)160



Tea Box

(L)160 x (W)60 x (H)65



Towel Dish

(L)230 x (W)180 x (H)11



Soap Dish

(L)90 x (W)110 x (H)11



Beverage Base

(L)160 x (W)95 x (H)35



Square Tissue Box
(L)140 x (W)140 x (H)142



Towel Tray
(L)219 x (W)152 x (H)25



Soap Dish
(L)110 x (W)80 x (H)28



Vase
(L)65 x (W)65 x (H)180



Soap Dispenser
(L)70 x (W)70 x (H)140



Dustbin
(L)228 x (W)178 / 176



Square Tissue Box

(L)130 x (W)130 x (H)135



Soap Dish

(L)100 x (W)80 x (H)20

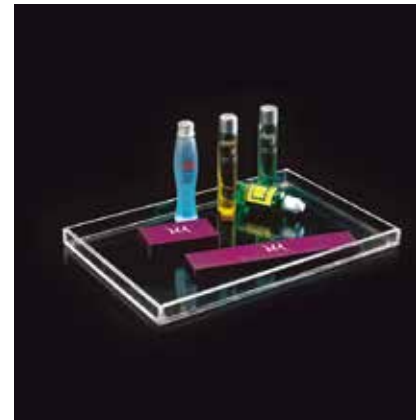

Tray

(L)315 x (W)210 x (H)20



Towel Plate

(L)140 x (W)110 x (H)18



Soap Dish

(L)100 x (W)80 x (H)20



Rectangle Tissue Box

(L)250 x (W)130 x (H)70



Drinks license

Model	Paper Size	Product Size	Material
N5100801	150 x 80 mm	150 x 60 x 92 mm	Wood + PMMA
N5100802	150 x 100 mm	150 x 60 x 112 mm	Wood + PMMA
N5100803	200 x 100 mm	200 x 60 x 112 mm	Wood + PMMA
N5100804	297 x 210 mm	297 x 60 x 222 mm	Wood + PMMA



DCS 23D6622 Cloth rack
Matte black color series



DCS 23D6622 Cloth rack
Matte black color series



DCS 23D6611
Cloth hanger stand
(L)460 x (W)280 x (H)1200



DCS 23D6613
Cloth hanger stand
(L)450 x (W)425 x (H)1150



DCS 23D6612
Cloth hanger stand
(L)460 x (W)255 x (H)1160



DCS 23DHHK1
Ironing Board
(L)1110 x (W)340 x (H)810
(L)925 x (W)335



DCS G10004
ICE BUCKET
(L)185 x (W)150 x (H)193/250 (1300 ml)



DCS G10007
ICE BUCKET
(L)135 x (W)135 x (H)147 (700 ml)



DCS G11003
BOTTLE OPENER





Creation & Service

F & B Service Trolleys

HOTEL SPECIALTY



CONTENTS

F & B Service Trolleys

040 Carving Trolleys	041 Flambe & Mobile Cooking Trolleys
042 Liquor & Wine Trolley / Pastry Trolley	043 Room Service Trolley
044 Modern Service Trolleys	045 Deluxe Service Trolleys
046 Public Service Trolleys	047 Service Station & Stand
048 Mobile Bar Station & Foldable Bar Display Shelf	049 Mobile Bar Display Shelf
050 Lucky Draw Box	



DCS 20D1110-102
Roast Beef Trolley
(L)1020 x (W)550 x (H)840~1120



DCS 20D1110-104
Roast Beef Trolley
(L)1020 x (W)550 x (H)840~1120



DCS 20D1160-001
Modern Carving Trolley
(L)1200 x (W)700 x (H)850~1480
Material: Stainless Steel
Wattage: Heating Lamp - 230v,
375w(max) x 2ea



DCS 20D7792-000
Modern Trolley-Carving Station
(L)1205 x (W)610 x (H)1476
Material: Stainless Steel 18-10;
Steel (powder coated);
Wood (MDF);
Artificial marble; tempered
glass; (transparent), phenol



DCS 20D7792-100
Modern Trolley-Carving Station
(L)1205 x (W)610 x (H)1480
Material: Stainless Steel 18-10;
Steel (powder coated);
Wood (MDF);
Artificial marble; tempered
glass; (transparent), phenol



DCS 19D9941
Carving Stand (Single)
450 x 450 x 813 / 230V, 375W(MAX)



DCS 19D9942
Carving Stand (Double)
658 x 526 x 813 / 230V, 750W(MAX)



DCS 20D2271
 Flambe Trolley
 (L)900(1345) x (W)500 x (H)810
 Material: Teak, Stainless Steel,
 Portable Gas Range



DCS 20D2275
 Royal Flambe Trolley
 (L)1000(1400) x (W)580 x (H)850
 Material: Oak, Stainless Steel,
 Portable Gas Range



DCS 20D2277
 Modern Flambe Trolley
 (L)1015 x (W)545 x (H)850



DCS 20D2276
 Flambe Trolley
 (L)1000 x (W)530 x (H)890



Built in 2pcs of induction range for cooking



본체 정면 고객용 접시진열장



Front clear glass partition



| 좌우 접이식 접시선반 |



| 기물수납용 트레이 |



| 좌우 휴지통 |

DCS 20D2281
 Modern Cooking Trolley
 (L)1200(W)700(H)850~1050
 Material: Wood, Stainless Steel
 Wattage: Induction Range (1)- 230v, 1.8kw (조리용)
 Induction Range (1)- 230v, 400w (보온용)



DCS 20D3311
Liquor Trolley
(L)800 x (W)660 x (H)820
Materia: Teak, Brass, Ice Bucket



DCS 20D3312
Liquor Trolley
(L)800 x (W)460 x (H)820
Materia: Teak, Brass, Ice Bucket



DCS 20D4414
Liquor Trolley
(L)1080 x (W)460 x (H)800
Materia: Teak, Brass



DCS 20D3313
DCS 20D3314
Royal Bar Trolley
(L)1130 x (W)490 x (H)760 (20D3313)
(L)940 x (W)490 x (H)760 (20D3314)
Materia: Wood, Brass & Stainless Accessory



DCS 20D4464
Wine Trolley
(L)980 x (W)600 x (H)840
Materia: Teak, Brass



DCS 20D7701
Dessert Trolley
(L)930 x (W)560 x (H)850
Materia: Teak, Brass



DCS 20D4466
Pastry Trolley
(L)1460 x (W)600 x (H)1300



DCS 20D7708-001
Dessert Wine Trolley
(L)910 x (W)510 x (H)1120



DCS 20D7708-003
Wine Trolley (Oval)
(L)770 x (W)480 x (H)815



DCS 20D7783
 Royal Room Service Trolley
 (L)1070 x (W)910 x (H)745
 Material: Stainless Steel 18-10
 Melamine coated Plywood,
 Stainless Steel Pie
 Wattage: 28.8kgs



DCS 11D8811-CAD
 Hot Food Warmer Caddy
 (L)1580 x (W)587 x (H)1830
 Material: Stainless Steel 18-10
 Powder coated Steel Pipe (Black)



DCS 20D7782
 Room Service Trolley
 (L)1070 x (W)900 x (H)745



DCS 20D7784
 Room Service Trolley
 (L)1100 x (W)900 x (H)790
 ※프레임형태는 라운드와 동일
 Material: Ply Wood with Melamine,
 Stainless Pipe



DCS 20D7774
 Room Service Trolley (Round type)
 (L)1020 x (W)550 x (H)750
 Material: Ply Wood with Melamine,
 Stainless Pipe



DCS 11D8811
 Hot Food Warmer
 (L)380 x (W)370 x (H)480
 Material: Stainless
 Wattage: 220V, 300W



DCS 11D8811BK
 Hot Food Warmer
 (L)380 x (W)370 x (H)480
 Material: Stainless
 Wattage: 220V, 300W



DCS 11D8811-98E
 Hot Box Trolley (6구식)
 (L)1070 x (W)590 x (H)1720



DCS 11D8811-78F
 Hot Box Trolley (ss) 스텐, 블랙
 (L)870 x (W)440 x (H)1660



DCS 20D7761
Modern Service Trolley-3
(L)1060 x (W)520 x (H)800



DCS 20D7791-OAK
Modern Service Trolley(OAK)
(L)1010 x (W)510 x (H)850
Material: Stainless Steel 18-10;
Steel (Powder Coated);
Wood (MDF)



DCS 20D7767
Modern Service Trolley(OAK)
(L)1000 x (W)530 x (H)890
Material: Stainless Steel, Wood (MDF)



DCS 20D7762
Modern Service Trolley-2
(L)1060 x (W)520 x (H)800



DCS 20D7791-000
Modern Service Trolley-2
(L)1010 x (W)510 x (H)850
Material: Stainless Steel 18-10;
Steel (Powder Coated);
Wood (MDF)



DCS 20D7768
Modern Service Trolley
(L)1000 x (W)530 x (H)890
Material: Stainless Steel, Wood (MDF)



DCS 20D4450
Wine Trolley 1
(L) 930 (1000) x (W) 530 x (H) 857



DCS 20D4452
Bar Trolley 1
(L)900 (1270) x (W)500 x (H)935





DCS 20D7752
 Palace Service Trolley
 (L)880 x (W)480 x (H)840
 Material: Teak, Brass & Stainless



DCS 20D7754
 Palace Service Trolley
 (L)880 x (W)480 x (H)840



DCS 20D7755
 Palace Service Trolley
 (L)880 x (W)480 x (H)840



DCS 20D7709
 Golden Service Trolley
 (L)880 x (W)480 x (H)815
 Material: Teak, Brass & Stainless



DCS 20D779-002
 Modern Service Trolley-3
 (L)1050 x (W)500 x (H)850



DCS 20D7711
 Economic Service Trolley
 (L)880 x (W)480 x (H)800



DCS 20D7712
 Economic Service Trolley
 (L)880 x (W)480 x (H)800



DCS 20D7716
 Economic Service Trolley
 (L)880 x (W)480 x (H)800



DCS 20D7773
Public Service Trolley
(L)800 x (W)500 x (H)750
Material: Ply Wood with Melamine
Stainless Pipe



DCS 20D7777
Service Trolley
(L)900 x (W)500 x (H)750
Material: Ply Wood with Melamine
Stainless Pipe



DCS 20D7779
Public Service Trolley
(L)850 x (W)500 x (H)750
Material: Ply Wood with Melamine
Stainless Pipe



DCS 20D7786
Public Service Trolley
(L)850 x (W)500 x (H)950
Material: Ply Wood with Melamine
Stainless Pipe



DCS 20D6612-001
플라스틱 3단 카트(로즈골드)
규격: 소형/대형
(L)829 x (W)441 x (H)943
(L)1070 x (W)505 x (H)900



DCS20D6613-001
플라스틱 3단 카트(블랙)대형-3면막힘
(L)1070 x (W)505 x (H)900



DCS 20D6612-004
플라스틱 3단카트 부착용통(소/대)
BSK-01/02
(L)330 x (W)320 x (H)270 15ℓ
(L)330 x (W)320 x (H)560 30ℓ



| 소형 |



| 대형 |

Item Number	Name	Size (mm)
DCS 20D6621-202	플라스틱 다용도 카트(그레이)소형	813 x 410 x 935
DCS 20D6622-203	플라스틱 다용도 카트(그레이)대형	1035 x 495 x 950
DCS 20D6622-328	플라스틱 다용도 카트 부착용 통(대)	335 x 245 x 560
DCS 20D6622-330	플라스틱 다용도 카트 부착용 통(소)	330 x 230 x 178



DCS 20D8802
Service Station
(L)1000 x (W)550 x (H)850



DCS 20D8807
Service Station Type-A
(L)900 x (W)520 x (H)1050



DCS 20D8804
Service Station
(L)1000 x (W)550 x (H)1000



DCS 20D8815
Tray Stand (목재)
(L)460 x (W)505 x (H)800



DCS 20D881D
Tray Stand
(L)580 x (W)400 x (H)840



DCS 20D8814
Tray Stand
(L)600 x (W)505 x (H)800



DCS 20D8816
Tray Stand (스텐레스)
(L)520 x (W)410 x (H)800



DCS 20D8817(BLACK)
Tray Stand
(L)390 x (W)500 x (H)910



DCS 20D8821
Handbag Stand
(L)486 x (W)293 x (H)417 (펼쳤을 시)



DCS 20D4424
Banquet Bar Trolley
(L)1800 x (W)700 x (H)1100
Material: Teak With Marble Plate,
Stainless Sink Table



DCS 20D4411
Mobile Wine Bar
(L)1800 x (W)700 x (H)1100



DCS TK-MB01-02
Mobile bar
(L)1800 x (W)800 x (H)1150



DCS TK-CC01-02
Coffee cabinet
(L)1200 x (W)700 x (H)2000



DCS TK-MB01-04
Mobile bar
(L)1800 x (W)800 x (H)1150



DCS TK-CC01-04
Coffee cabinet
(L)1200 x (W)700 x (H)2000



DCS TK-MB01-03
Mobile bar
(L)1800 x (W)800 x (H)1150



DCS TK-CC01-03
Coffee cabinet
(L)1200 x (W)700 x (H)2000





DCS TK-HL01-05
Floor Type Heat Lamp
(W)350 x (H)1800

F & B Service Trolleys



DCS TK-DY01-03
Upright buffet display
(L)1900 x (W)500 x (H)2000



DCS TK-DY01-01
Upright Buffet Display
(L)1700 x (W)450 x (H)2000



DCS TK-DY01-02
Upright Folding Buffet Display
(L)1600 x (W)500 x (H)1800



DCS TK-DY01-02
Upright Folding Buffet Display
(L)1600 x (W)500 x (H)1800



DCS GE-DP11S
Upright Folding Buffet Display
(L)1600 x (W)1500 x (H)1800



DCS GS-DP03T
Upright Folding Display Trolley
(L)1100 x (W)2000x (H)1200



Customizable pattern



DCS 7225B
Lucky Draw
(L)735 x (W)650 x (H)855



DCS 7225C
Lucky Draw
(L)735 x (W)650 x (H)825



DCS 7225A
Lucky Draw
(L)530 x (W)500 x (H)460



Creation & Service

Banquet Furniture & Carts

HOTEL SPECIALTY



CONTENTS

Banquet Furniture & Carts

055-057
Quantum Tables

060
Banquet Folding Tables

062
Training Folding Tables & Chairs

064-065
Podiums

067
Banquet Wedding Chairs

069
Table & Chair Cart

071
Wedding Event Equipment

0731
Lazy Susan

075
Cross Buffet Tables

077
Signage Stand

058-059
Convex Tables

059
Conference Tables

063
Conference Folding Tables

066
Banquet Chairs

068
Banquet Utility Goods

070
Portable Stage

072
Mobile Partition

074
Display Table

076
Cocktail Table

SKS HOSPITALITY

HOTELS & HOSPITALITY



BUFFET COLLECTION



BUFFET STATION



BUFFET TABLE



CHAIR COLLECTION



HOUSEKEEPING



ROOM SERVICE



STAGING























GUESTROOM























FRONT OFFICE

WHAT WE DO

SKS HOSPITALITY
HOTELS & HOSPITALITY

- 01 pretreatment plant 
- 02 laser cutting: 2D & 3D 
- 03 robotic welding 
- 04 powder coating 
- 05 chemical edging 
- 06 chemical forming 
- 07 chemical moulding 
- 08 cutting 
- 09 stamping 
- 10 drilling 
- 11 deburring 
- 12 punching 
- 13 bending 
- 14 polishing 
- 15 milling 
- 16 leveling 
- 17 folding 
- 18 metal forming 
- 19 spot welding 
- 20 upholstery 

ICON MASTER

-  NEW PRODUCT
-  QUALITY
-  COMFORT
-  BESTSELLER
-  USER-FRIENDLY
-  STACKING
-  MODULAR
-  RECHARGEABLE
-  ACTION BACK
-  LIGHTWEIGHT
-  DURABLE
-  ARMREST
-  LED LIGHT
-  RETRACTABLE/SLIDE
-  WRITING TABLET
-  FOLDABLE
-  ELECTRICAL
-  USB PORT
-  MAXIMUM CAPACITY
-  LINKING
-  WEIGHT

 USER-FRIENDLY  DURABLE  FOLDABLE



FEATURES of QUANTUM TABLE

TABLE TOP



The table top are made from double wood paneling in wood with an internal honeycomb structure.

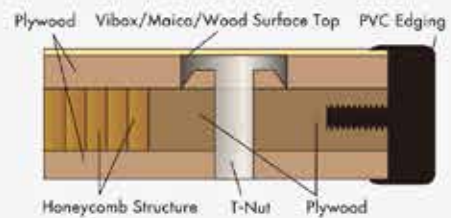

Concealed T-nut with bolts are designed for the table specially to further strengthen the main structure for durability and heavy duty usage.

LEG BASE



Square Tube.
Constructed from a 30mm mild steel square tube in standard black epoxy powder coating finish.



Auto Locking System.
Double spring loaded **SPRINGO™** mechanism provides auto locking system.



PVC Studs.
PVC studs on the leg frames provide protection of the surfaces when storing in stacked positions.



Locking Device.
When in use, safety catch locks the base in position, preventing it from collapsing. A second locking device, also lock it in position, preventing the base this time from opening when folded during transfer and storage.



Folding Mechanism.
The mechanisms of the table are designed for foldaway purposes and also acts as base during storage and stacking.



Adjustable Gliders.
Nylon adjustable gliders are (not detachable) fitted on the leg base to stabilize the table on uneven flooring and to protect floor surfaces also.

BANQUET & CONFERENCE TABLE COLLECTIONS

 USER-FRIENDLY
  DURABLE
  FOLDABLE

MATERIAL

- ☑ Wood (top)
- ☑ Mild steel (leg base)

FEATURES

- ☑ Table top - 18mm thick honeycomb structure in laminated/vibox pad finish with Edge Plus Edging.
- ☑ Folding mechanism with zinc plating locking device releaser.
- ☑ Polypropylene adjustable gliders.

**CRESCENT TABLE
(CR-T SERIES)**



**SQUARE TABLE
(SQ-T SERIES)**







**QUARTER ROUND TABLE
(QR-T SERIES)**



**RECTANGULAR TABLE
(RC-T SERIES)**

DIMENSION (mm)

MODEL	L	W	H	FOLD HEIGHT	M ³
RECTANGULAR TABLE (RC-T SERIES)					
RC-T 18/60	1530	456	760	105	0.07
RC-T 18/72 	1830	456	760	105	0.09
RC-T 18/84	2135	456	760	105	0.10
RC-T 18/96	2440	456	760	105	0.12
RC-T 20/72 	1830	500	760	105	0.10
RC-T 22/72	1830	560	760	105	0.11
RC-T 24/72 	1830	610	760	105	0.12
RC-T 30/48	1220	760	760	105	0.10
RC-T 30/60	1530	760	760	105	0.12
RC-T 30/72 	1830	760	760	105	0.15
RC-T 30/84	2135	760	760	105	0.17
RC-T 30/96	2440	760	760	105	0.20
RC-T 36/60	1530	915	760	105	0.15
RC-T 36/72 	1830	915	760	105	0.18
SQUARE ROUND TABLE (SQ-T SERIES)					
SQ-T 30 	760	760	760	105	0.06
SQ-T 36	915	915	760	105	0.09
CRESCENT TABLE (CR-T SERIES)					
					
CR-T 30(4) - Ø3024 	2140	760	760	105	0.22
CR-T 30(5) - Ø3028	1780	760	760	105	0.17
					
CR-T 36(4) - Ø3630	2567	915	760	105	0.32
CR-T 36(5) - Ø3619	2127	915	760	105	0.24
QUARTER ROUND TABLE (QR-T SERIES)					
QR-T 30 	760	760	760	105	0.06
QR-T 36	915	915	760	105	0.09

ADD ON ACCESSORIES - FOLDABLE MODESTY PANEL

 USER-FRIENDLY
  DURABLE
  FOLDABLE



DIMENSION (mm)

MODEL	L	H	THICKNESS	M ³
SINGLE FOLD MODESTY PANEL				
EP-RCT 18/60	1190	160	2	0.08
EP-RCT 18/72	1550	160	2	0.10
EP-RCT 20/72	1550	160	2	0.11
EP-RCT 24/72	1550	160	2	0.13
EP-RCT 30/60	1190	160	2	0.14
EP-RCT 30/72	1550	160	2	0.17
DOUBLE FOLD MODESTY PANEL				
EP-RCT 18/60	1190	320	2	0.08
EP-RCT 18/72	1550	320	2	0.10
EP-RCT 20/72	1550	320	2	0.11
EP-RCT 24/72	1550	320	2	0.13
EP-RCT 30/60	1190	320	2	0.14
EP-RCT 30/72	1550	320	2	0.17

FEATURES of FOLDABLE MODESTY PANEL



Folding Mechanism.
Mild steel folding mechanism bracket in zinc plating.

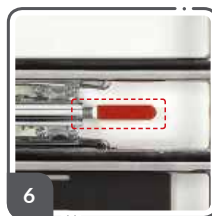

Lock Releaser.
Mild steel in zinc plating locking device releaser.

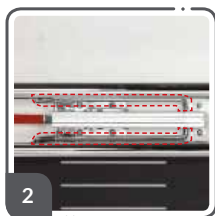

Rod Support Mechanism.
Solid rod support mechanism in galvanized finish.

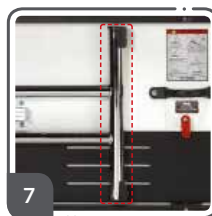

Mild Steel Tube.
Round mild steel tube in (25~30µm) chromed finish.



Handle.
Mild steel handle in black epoxy coating.



Foldable Modesty Panel.
Mild steel cold roll plate double fold modesty panel (laser cut) in black powder coating.



Bottom Glider.
T-Leg base bottom glider:
Material: PP
Finish: Black



Nylon lock.
Nylon locking device.



Supporting Bar.
Mild steel rectangular supporting bar in powder coating.

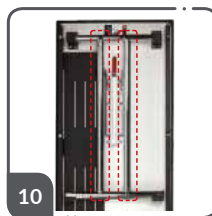

Mild Steel.
Round mild steel tube in chrome finish.



DCS 30D1120 / 30D1121
DCS 30D1122 / 30D1123
Round Table

(Φ)1800 x 730 10인용, (Φ)1500 x 730 8인용
(Φ)1200 x 730 6인용, (Φ)900 x 730 4인용



DCS 30D1151
Oval Table

2100 x 1200 x 730 / 12인용



DCS 30D1110
Rectangular table

1800 x 600 x 730



DCS 30D1111
Seminar Table

1800 x 450 x 730
900 x 450 x 730



DCS 30D1113
IBM Table

(L)1800 x (W)450 x (H)730



DCS 30D1112
Square Table

(L)900 x (W)900 x (H)730

DCS 30D1114

IBM Table with Panel
(L)1800 x (W)450 x (H)730



DCS 30D1130
half Round table

Φ1800 x 1/2 x 730
Φ1600 x 1/2 x 730
Φ900 x 1/2 x 730



DCS 30D1140
Quarter Round table

Φ1800 x 1/4 x 730
Φ1600 x 1/4 x 730
Φ900 x 1/4 x 730



DCS 30D1150
Crescent table

Φ3600 x Φ1800 x 1/4 x 730
Φ3200 x Φ1600 x 1/4 x 730

Various Detail

1. 합판 & 알루미늄테두리



2. 레자상판 & PVC테두리



3. 안전형: 록킹핀 스탠드



4. 기본형: 칼집 스탠드



5. 스프링 한지방식



DCS CD1100-18B
Folding Table (6인용)
(L)1800 x (W)800 x (H)740



DCS CD1100-15B
Folding Table (4인용)
(L)1500 x (W)800 x (H)740



DCS CD1100-18RB
Folding Table
세팅규격 ϕ 2600 / 12인석
(L)1840 x (W)800 x (H)740



DCS F0D2271-SW0
Frame color : White/Black
200 x 650~800 x 760
1500 x 650~1200 x 760
1800 x 650~1200 x 760
2400 x 1200 x 760
Function Executive director table/manager table



DCS SE-F020A/B

Seminar Table

(L)1200/1400/1600/1800 x (W)400~600 x (H)750



DCS SE-F001A/B

Seminar Table

(L)1200/1400/1600/1800 x (W)400~600 x (H)750



DCS SE-F001C

Half round Table

(L)1200/1400/1600/1800
x 1/2 x (H)750

DCS M04

Office Chair





DCS F0D2271
Center Folding Conference Table
(L)3000 x (W)1200 x (H)755



How-to-video



How-to-Video



- Smooth & flexible operation
- Elegant shape
- Safe design
- High quality



DCS 33D1101
Lectern
(L)920 x (W)520 x (H)1270



DCS 33D2205
Lectern
(L)800 x (W)500 x (H)1270



DCS 33D1106
Lectern
(L)570 x (W)550 x (H)1200



DCS 33D2208
Speech Stand
(L)650 x (W)500 x (H)1200



DCS 33D2201
Lectern
(L)700 x (W)500 x (H)1200



DCS 33D2217
Speech Stand
(L)580 x (W)730 x (H)1210



DCS 33D2209
Lectern
(L)700 x (W)500 x (H)1200



DCS 33D2212(S)
DCS 33D2213(L)
Speech Stand (인터포디움)
(L)585 x (W)510 x (H)1245
(L)800 x (W)600 x (H)1250



DCS 30D2219
Speech Stand
(L) 570 x (W)600 x (H)1300



How-toVideo

DCS 33D2219-003
 Speech Stand (높이조절식)
 (L)560 x (W)420 x (H)910~1270



DCS 33D2217-001
 Lectern
 (L)610 x (W)510 x (H)965~1143



DCS 33D2218
 Speech Stand
 (L)600 x (W)500 x (H)1200



DCS 33D2218-001
 Speech Stand
 (L)600 x (W)500 x (H)1200



DCS 33D2217-003
 Lectern
 (L)610 x (W)510 x (H)965~1143



Y5 Natural

Y5 Whisky

Y5 Mahogany



DCS 31D1127
Crown Chair
(L)450 x (W)500 x (H)460~930



DCS 31D1125
Stacking Chair
(L)450 x (W)500 x (H)460~930



DCS 31D1123
Round Chair
(L)450 x (W)500 x (H)460~930



DCS 31D1124
Round Chair
(L)450 x (W)500 x (H)460~930



DCS 31D334E
Modern Chair



DCS 31D3309-400
Modern Chair



DCS 31D1100-117
Modern Chair



DCS 31D1100-118
Modern Chair
(L)460 X (W)595 X (H)470~840



DCS 31D3315-1D0
Chair
(L)440 x (W)440 x (H)570~870



DCS 31D3329-100
Chair
(L)645 x (W)440 x (H)580~850



DCS 31D3315-C
Chair
(L)440 x (W)440 x (H)570~870



DCS 31D3314-RM0
Arm Chair
(L)645 x (W)440 x (H)580~850



DCS 31D1183-004
Arm Chair
(L)600 x (W)650 x (H)580~1100



DCS 31D1153
Arm Chair
(L)600 x (W)650 x (H)580~1100





DCS 31D1142
Wedding Chair
(L)390 x (W)400 x (H)470~910



DCS 31D1141
Wedding Chair
(L)390 x (W)400 x (H)470~910



DCS 31D1145
Wedding Chair
(L)390 x (W)400 x (H)470~910



DCS 31D1142-008
Wedding Chair (PC)
(L)390 x (W)400 x (H)470~910



DCS 31D1144
Wedding Chair
(L)390 x (W)400 x (H)470~910



DCS 31D1146
Wedding Chair
(L)390 x (W)400 x (H)470~910



DCS 31D1143
Wedding Chair
(L)390 X (W)400 X (H)470~910



DCS 31D1143-010
Wedding Chair (PC)
(L)390 x (W)400 x (H)470~910



DCS 31D1100-101
Bar Stool



DCS 31D1100-002
Bar Stool



DCS 31D1100-003
Bar Stool



DCS 80D1120
Baby Chair
(L)636 X (W)583 X (H)773



DCS 31D1109-113
Wooden Baby Chair
(L)500 X (W)560 X (H)930



DCS 31D1109-001
AL Baby Chair
(L)500 X (W)560 X (H)930



DCS 33D3305
White Board Stand
(L)1800 x (W)1200 x (H)1950
(L)1800 x (W)900 x (H)1850
(L)1200 x (W)900 x (H)1850



DCS 51D1106
chart
(L)640 x (H)1790
Easel stand with pad



DCS 33D3323
Ice Carving Stand (Large)
(L)1100 x (W)500 x (H)800
Material: Wood, Stainless, Light



DCS 33D3324 / 33D3325
Ice Carving Stand
(L)1350 x (W)700 x (H)900
(L)900 x (W)600 x (H)850 mm
Material: Stainless Frame, Wooden Plate



DCS 21D1152
Ice Carving Lift Truck
(L)1200 x (W)700 x (H)1050
Material: Stainless Frame, Wooden Plate



DCS 33D3321
Ice Carving Stand
(L)950 x (W)600 x (H)220
Material: Stainless Frame, Acryl Plate, Light

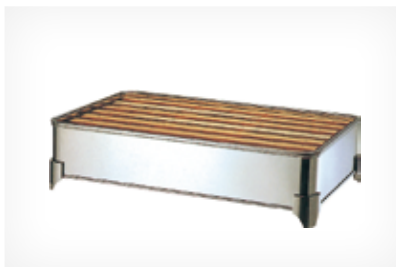

DCS 33D3322
Ice Carving Stand
(L)950 x (W)600 x (H)180
Material: Stainless Frame, Wooden Plate



DCS 21D1151
Ice Carving Truck
(L)1000 x (W)650 x (H)850
Material: : Wood, Stainless, Light



DCS JW-SLI
Sliding Ice Caddy
(L)585 x (W)800 x (H)745
Capacity: 110L



DCS 21D4401
Stainless Ice Cart (140L)
(L)750 x (W)550 x (H)750
Capacity: 140L



DCS 21D1132
Ice Beer Cart
(L)850 x (W)630 x (H)1150



DCS 21D3310
Round Table Cart
(L)1300(1650) x (W)750 x (H)1210
Material: Steel Frame with Powder Coating, Rubber Mat



DCS 21D3310-001
Round Table Cart
(L)1930 x (W)970 x (H)1250
Material: Steel Frame with Powder Coating, Rubber Mat



DCS 21D3333
Folding Table Cart
(L)1890 x (W)990 x (H)1520
Material: Steel Frame with Powder Coating, Rubber Mat



DCS 21D3332-001
Folding Table Cart
(L)1870 x (W)970 x (H)1100
Material: Steel Frame with Powder Coating, Rubber Mat



DCS 21D3331
Folding Table Cart
(L)1800 x (W)800 x (H)950
Material: Steel Frame with Powder Coating, Rubber Mat



DCS 21D3331-001
Folding Table Cart
(L)1100~1800 x (W)800 x (H)950 (확장형)
Material: Steel Frame with Powder Coating, Rubber Mat



DCS 21D3301
Stacking Chair Cart (스텐)
(L)900 x (W)500(350) x (H)1300
Material: Stainless



DCS 21D3304
Stacking Chair Cart (카펫)
(L)900 x (W)665 x (H)1255



DCS 21D3303
Stacking Chair Cart (카펫/보조바퀴)
(L)1000 x (W)665 x (H)1255



DCS 21D2201 / 21D2202
Grand Piano Lift Cart
(L)1150/885 x (W)1480/1100 x (H)630



DCS 30D4401-002
Portable Stage-1
(L)1200 x (W)2400 x (H)200
(L)1200 x (W)2400 x (H)400~600



DCS 30D4401-T03
Virgin Load-1
(L)1800 x (W)2400 x (H)200
(L)1800 x (W)2400 x (H)400~600



DCS High stage
High stage
1200 x 2400 x (H)600~800



DCS 30D6611 Step-1
Step-1
(L)900 x (W)300 x (H)200



DCS 30D6612 Step-2
Step-2
(L)900 x (W)600 x (H)400



DCS 30D6613 Step-3
Step-3
(L)900 x (W)900 x (H)600



DCS 21D3335
Dancing Floor Cart
(L)1150 x (W)700 x (H)900
Material: Steel Frame with Powder Coating

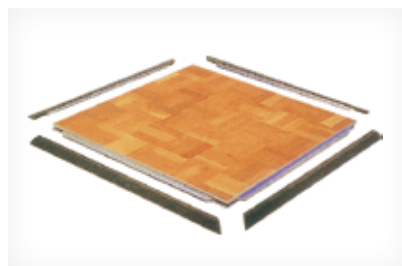

DCS 30D5501
Dancing Floor
(L)924 x (W)924 x (H)24
트림 (사이드몰딩)



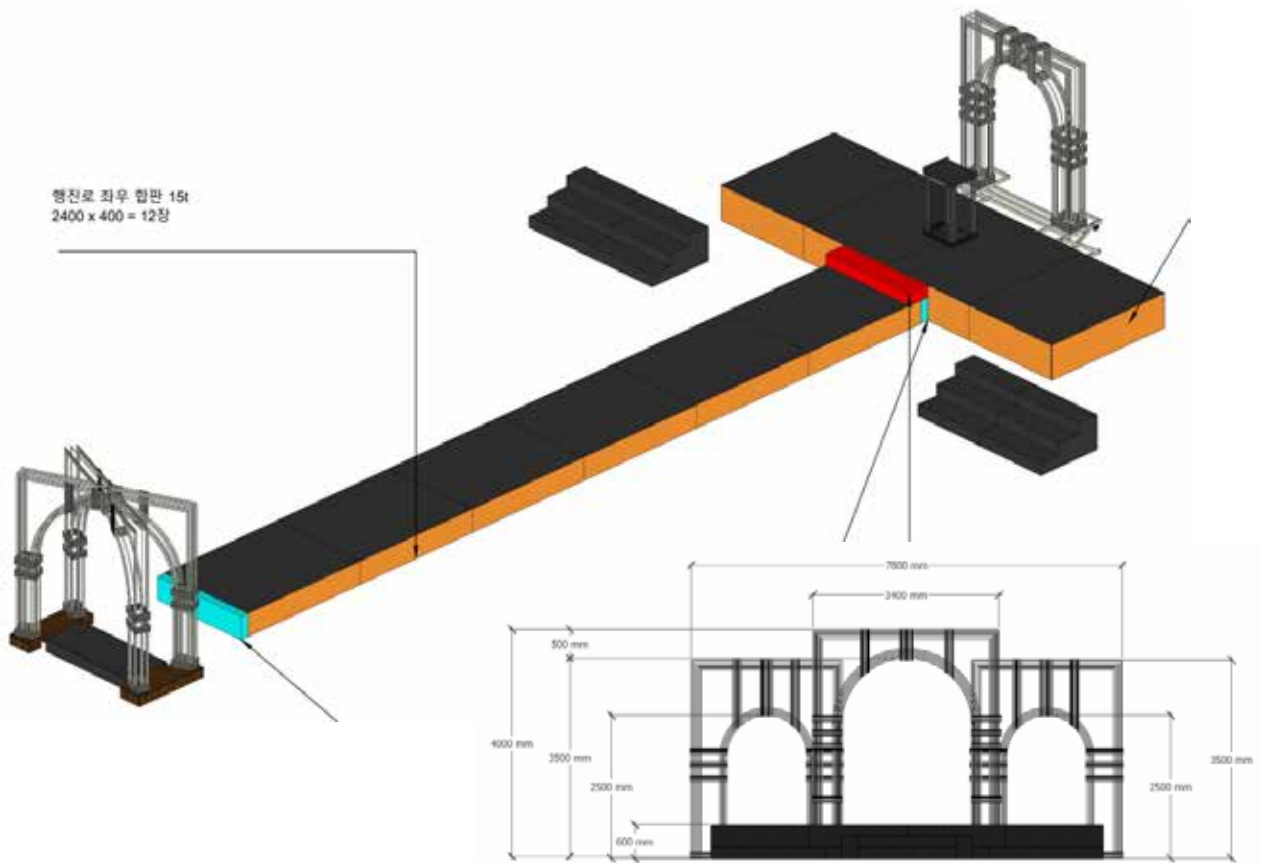

조립식 S자 버진로드



조립식 곡선 버진로드



파고라 세트



DCS 33D4413
Movable Partition-3
(L)1800 x (W)600 x (H)1800



DCS GE-PT01A
Movable Partition-3
(L)520 x (H)1800mm x 3 Units



DCS GE-PT02A
Movable Partition-3
(L)520 x (H)1800mm x 3 Units



DCS 33D4415
Movable Partition-5
(L)3000 x (W)600 x (H)1800



DCS 33D4420-001
Movable Partition-1
(L)2200 x (W)500 x (H)1950



Optionally install caster for use

DCS TK-PN01-01
Partition
(L)600 x (W)40 x (H)2000 x 4



DCS TK-PN01-02
Partition
(L)2000 x (W)200 x (H)2000



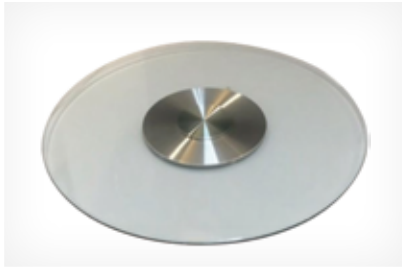

DCS 35D1115
 Lazy Susan - 투명
 (Φ)600, 900, 1000, 1200
 (강화유리 10T, 회전판일체형)



DCS 35D1114
 Lazy Susan - Black pearl
 (Φ)600, 900, 1000, 1200
 (강화유리 10T, 회전판일체형)



DCS 30D1108
 Lazy Susan - Wire Glass(실버)
 (Φ)600, 900, 1000, 1200
 (강화유리 10T, 회전판일체형)



DCS 35D1107
 Lazy Susan - Wire Glass (스카이)
 (Φ)600, 900, 1000, 1200
 (강화유리 10T, 회전판일체형)

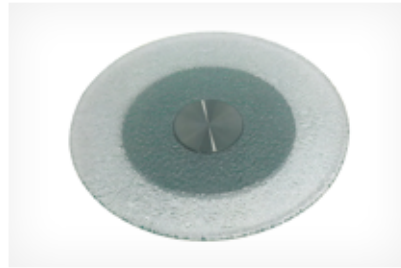

DCS 35D1112
 Lazy Susan - Melt Glass-1
 (Φ)600, 900, 1000, 1200
 (강화유리 10T, 회전판일체형)



DCS 21D3350
 Lazy Susan Trolley
 (L)1200 x (W)640 x (H)1280





DCS 30D3310
Classic Oblong Table

(L)1800 x (W)850 x (H)1100
(L)1650 x (W)850 x (H)950
(L)1500 x (W)850 x (H)800



DCS 30D3313
Classic Square Table

(L)850 x (W)850 x (H)950
(L)700 x (W)700 x (H)800



DCS 30D3321
Classic Round Table

(Φ)900 x (H)800
(Φ)900 x (H)950



DCS 30D7710
Modern Nesting Table

(L)1800 x (W)850 x (H)1100
(L)1650 x (W)850 x (H)950
(L)1500 x (W)850 x (H)800
(L)850 x (W)850 x (H)950
(L)700 x (W)700 x (H)800



DCS STD1101-160
Nesting Oblong Buffet Table

(L)1800 x (W)850 x (H)1100
(L)1650 x (W)850 x (H)950
(L)1500 x (W)850 x (H)800



DCS STD1101-124
Nesting Square Buffet Table

(L)500 x (W)500 x (H)1000
(L)400 x (W)400 x (H)900



DCS TK-BT03-01
Arc buffet table(square)

(L)1200 x (W)600 x (H)850
(L)1300 x (W)600 x (H)950
(L)1400 x (W)600 x (H)1050



DCS TK-BT03-02
Arc buffet table(square)

(L)600 x (W)600 x (H)850
(L)700 x (W)700 x (H)950
(L)800 x (W)800 x (H)1050



DCS 20D880P-002
A-Stand

(L)1500 x (W)400 x (H)1500



DCS 30D8810
 Cross Oblong Table
 Size: (L)1800 x (W)850 x (H)950
 Size: (L)1800 x (W)850 x (H)850
 Size: (L)1800 x (W)850 x (H)750

DCS 30D8820
 Cross Round Table
 Size: (Φ)900 x (H)950
 Size: (Φ)900 x (H)850
 Size: (Φ)900 x (H)750

DCS 30D8813
 Cross Square Table
 (L)850 x (W)850 x (H)950
 (L)700 x (W)700 x (H)800

DCS 30D8815
 Cross Square Table (High)
 (L)550 x (W)550 x (H)950



DCS 30D9910
 Cross Oblong Table-2Layer
 (L)1700 x (W)760 x (H)750
 Material : Wood, Stainless Steel

DCS 30D9914
 Cross Square Table-2Layer
 (L)1022 x (W)1022 x (H)900
 Material : Wood, Stainless Steel



CUSTOMIZABLE COUNTERTOP STYLE

Star series



Ice learning series



Stone grain series



Wood series



DCS TK-BT01-03
 Foldable Buffet Table (Round)

(W)800 x (H)750
 (W)800 x (H)850
 (W)800 x (H)1150



DCS TK-BT01-04
 Foldable Buffet Table (Square)

(L)900 x (W)800 x (H)750
 (L)900 x (W)800 x (H)950
 (L)900 x (W)800 x (H)1150



DCS 30D2272
Cocktail Table
(Φ)560 x (H)665~1030



DCS 30D2275
Cocktail Table
(Φ)600 x (H)730~1080



DCS 30D2276
Cocktail Table
(L)700 x (W)700 x (H)750~1100



DCS 30D2274
Folding Cocktail Table
(Φ)600 x (H)850/950/1050



DCS 30D2277
Cocktail Table
(L)600 x (W)600 x (H)800~1060mm



DCS 30D2278
Cocktail Table

Choice of Color Option



White Red Black



DCS TK-CT01-01
Cocktail Table
(W)700 x (H)1050



DCS TK-CT01-02
Cocktail Table
(W)700 x (H)1050



DCS TK-CT01-03
Cocktail Table
(W)750 x (H)1050



DCS TK-CT01-04
Cocktail Table
(W)800 x (H)1050



DCS TK-SS01-01
Signage stand(A4)
(L)300 x (W)250 x (H)1300

DCS TK-SS01-02
Signage stand(A3)
(L)500 x (W)300 x (H)1400

DCS TK-SS01-03
Signage stand(A2)
(L)620 x (W)300 x (H)1500



DCS 62D1101
Number Stand
Φ100 x H445~600



DCS 62D1103
Number Stand
Φ100 x H445~620



DCS 62D1102-002
Table Number Stand
Φ100 x (H)365



DCS 62D1105
Table Number Stand
Φ80 x H355



DCS 62D1101-012
Flower Vase
Φ80 x H380



DCS 62D1105-001
Number Stand
Φ100 x H500



DCS 62D1102-001
Table Number Stand
110 x 105 x (H)437 (80 x 150)



DCS 62D1102-003
Table Number Stand
135 x 100 x (H)460 (123 x 188)



Creation & Service

Buffet Station & Display Table

HOTEL SPECIALTY



CONTENTS

Buffet Station & Display Table

080-081
Delight Grand Wheel

092
Live Buffet Stations

094
Family Restaurant Salad Bar 2

096-097
Family Restaurant Salad Bar 4

099
Ice bed

101
Barbecue Carts

103
Event Display Wagon

082-091
Foldable Mobile Buffet Station System

093
Family Restaurant Salad Bar 1

095
Family Restaurant Salad Bar 3

098
상설뷔페 스테이션

100
Event Station

102
Show Case & Event Wagon

104-105
CRYSTAL CLEAN-GUARD



딜라이트 그랜드휠
Delight Grand Wheel

런던아이를 모티브로 개발한 2024년 신제품 회전식 진열대입니다.
 뷔페에서, 카페에서, 로비에서, 명품샵에서,
 귀한 고객을 위해 정성스레 준비한 맛난 음식과 멋진 명품들을
 딜라이트 그랜드휠과 함께 더욱 멋지고 고급스럽게 연출해 보세요

"The Best Food display device for Buffet & Bakery cafe"

"The Fantastic display device for Lobby Lounge or Luxury shop"

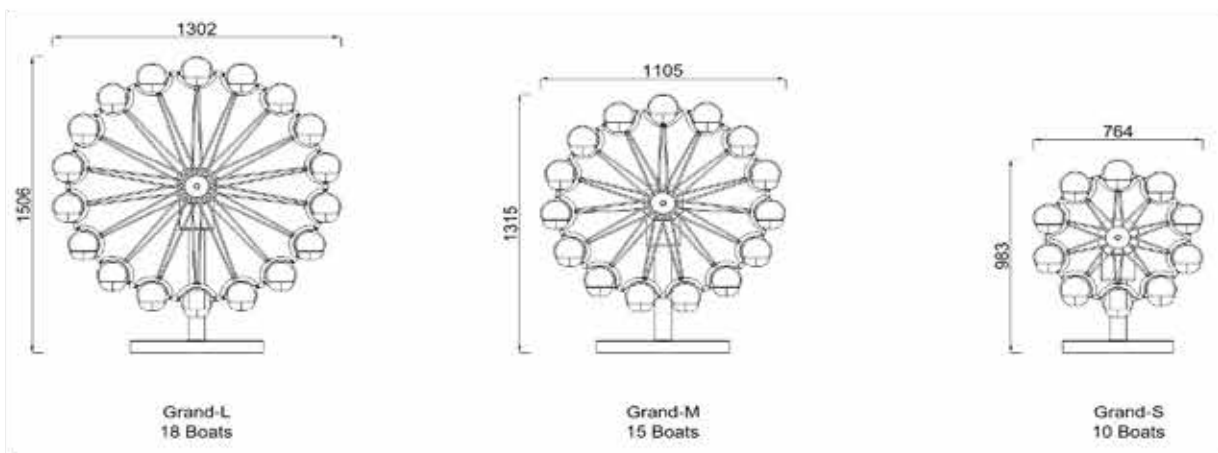

주요 제원

- 알루미늄 회전휠과 스테인레스 기둥과 바닥판, 모터커버
- 소음없이 정속한 DC모터사용, 자유롭게 회전속도 조절가능
- 항상 자동으로 수평을 유지해 주며 탈부착이 손쉬운 특별한 구조의 디스플레이 보트제공
- 100% 국산제작 개발품으로서 신속하고 철저한 AS관리와 품질 책임보장

| 샴페인 골드 |

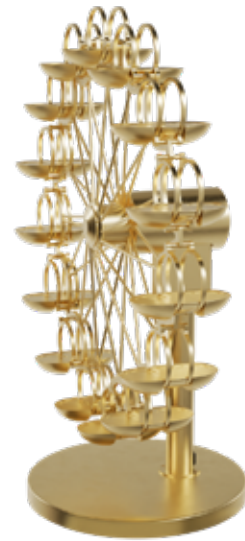

| 로즈 골드 |

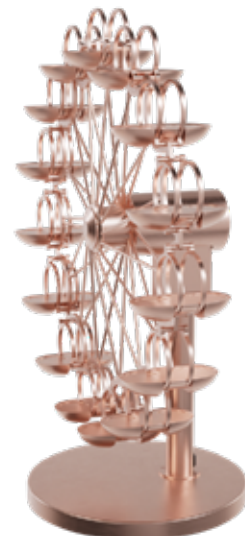



Foldable Mobile Buffet Station System

연회행사는 규모와 내용이 변화무쌍하여 상설뷔페와 같은 시스템으로는 행사의 준비와 정리에 너무 많은 인력과 시간이 필요 합니다.

따라서 연회장에서 사용하는 가구와 장비는 가벼우면서도 견고하며 또 고객들에게 멋진 인상을 줄 수 있도록 디자인도 고급스러워야 합니다.

이번에 저희 대원씨엔에스에서 이러한 연회장의 특성에 맞는 신제품 뷔페스테이션을 개발하여 고객님들께 선보이게 되었습니다.

부디, 대원씨엔에스의 Foldable Mobile Buffet Station System과 더불어 귀사의 성공적인 비즈니스를 기원합니다.





본체 프레임을 알루미늄으로 제작하여 가벼우며 디자인캐스터를 부착하여 이동이 편리합니다.
 추가 옵션으로는 본체 내부에 LED조명과 전원콘센트 설치가 가능합니다.
 그리고 해체시 이동식 모듈 트로리에 모듈을 적재하여 모듈 설치 및 보관을 쉽고 빠르게 할 수 있게 도와줍니다.

제품의 특징점

- * 접이식 구조의 신제품으로 설치와 해체, 이동과 보관이 매우 쉽고 편리합니다.
- * 가볍고 견고한 알루미늄프레임과 스크래치에 강한 아노다이징으로 마감합니다.
- * 허용하중 100kg의 견고한 바퀴를 사용하여 이동이 쉽고 내구성이 뛰어납니다.
- * 전기를 편하고 안전하게 연결하기 위한 Power Station 제공
- * 고객사 인테리어에 맞춰 다양한 칼라의 판넬사용, 원하는 그림과 로고 UV인쇄가능
- * 평상판의 앞뒷면을 두가지 칼라로 제작하여 , 뒤집어서 양면으로 사용가능합니다.
- * **특허출원**한 탈착식 접시진열장, 측면 여닫이도어, 전기코드선 자동감기장치 부착.
- * 다양한 기능의 모듈사용으로 다채로운 뷔페행사를 연출할 수 있습니다.
- * 100% 국내제작으로 소량주문제작이 가능하고 신속하고 철저한 AS로 품질책임보장





상판의 규격별 수량과 선택가능한 기능 (모듈)

규격	수량	용도							
1/4 : 800 x 450	4개/대	평상판	인덕션모듈	숯모듈	덤섬모듈	누들모듈	너무작음	너무작음	너무작음
1/3 : 800 x 600	3개/대	평상판	인덕션모듈	숯모듈	덤섬모듈	누들모듈	카빙모듈	아이스빈	그리들모듈
1/2 : 800 x 900	2개/대	평상판	불필요	불필요	불필요	불필요	카빙모듈	아이스빈	그리들모듈

* 1/4은 1/2과 혼용사용이 가능, 그러나 1/3은 다른 규격과 혼용할 수 없음

기타 상판규격과 별도로 선택가능한 모듈

히팅램프 BBQ행거 스시쇼케이스

인덕션모듈의 전기용량 선택요령

- (1) 차핑디쉬와 같이 보온기능만 필요할 경우에는 워머용 인덕션렌지 0.4kw/H 선택.
- (2) 파스타요리 등 즉석조리가 필요한 경우에는 인덕션렌지를 1.8kw~2.5kw/H를 선택 사용.

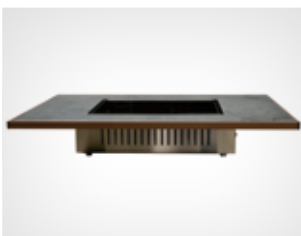

| Induction Module |

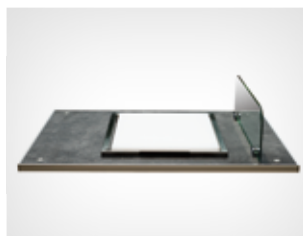

| Cutting Board Module |

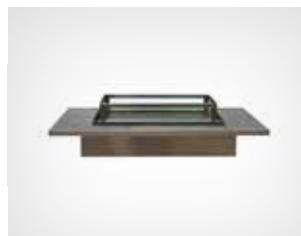

| Ice Bin (1/3) Module |



| BBQ Module |

다양한 상판모듈로 Live cooking 등의 보다 수준 높은 서비스를 제공할 수 있습니다.

모듈 종류로는 평상판, 인덕션모듈, 아이스모듈, 딤섬, 슝과 누들모듈, 카빙모듈, 그리들모듈 등 다양한 종류가 있어 행사의 컨셉에 맞게 구성하여 운영이 가능합니다.



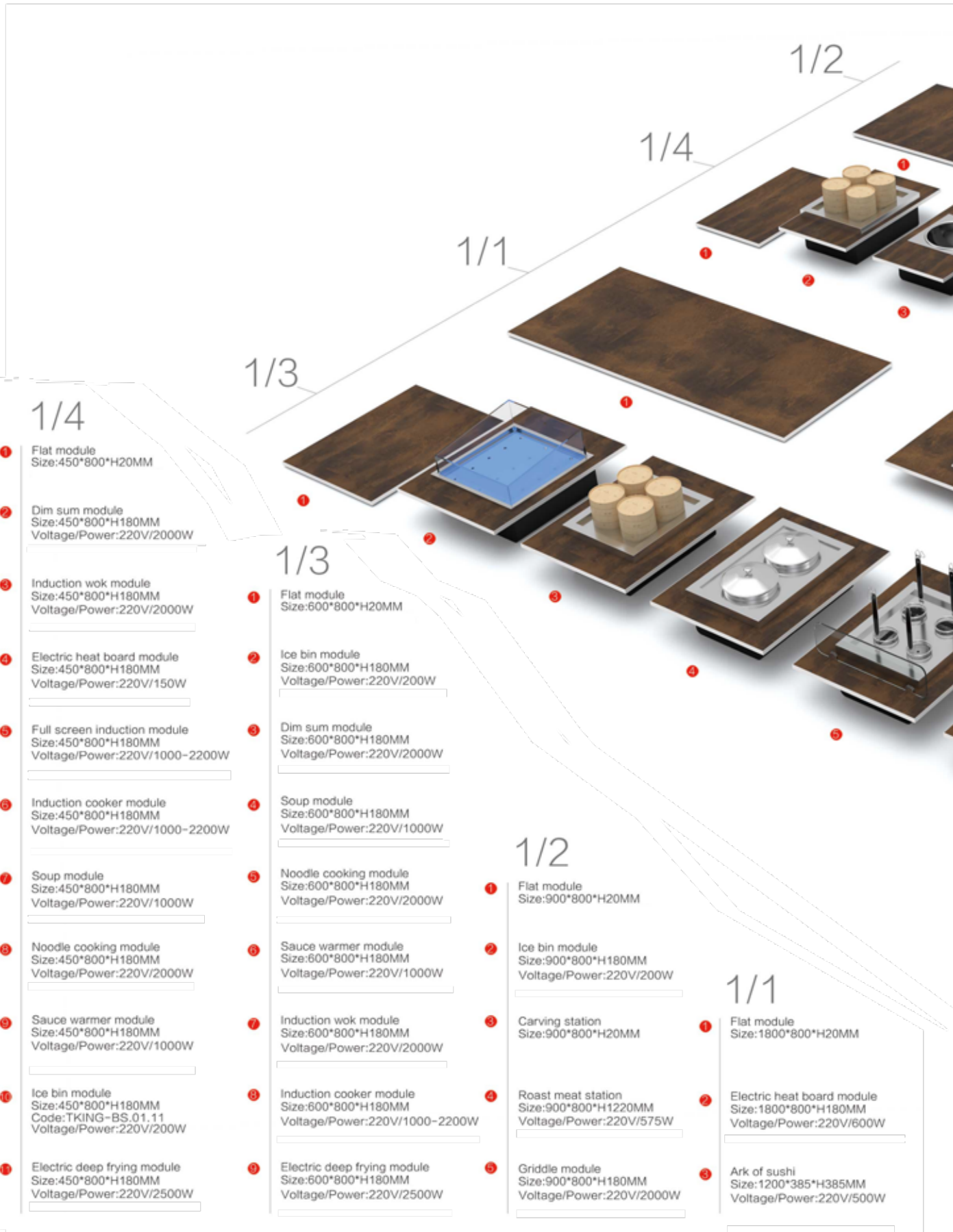

- 1/4**
- 1 Flat module
Size:450*800*H20MM
 - 2 Dim sum module
Size:450*800*H180MM
Voltage/Power:220V/2000W
 - 3 Induction wok module
Size:450*800*H180MM
Voltage/Power:220V/2000W
 - 4 Electric heat board module
Size:450*800*H180MM
Voltage/Power:220V/150W
 - 5 Full screen induction module
Size:450*800*H180MM
Voltage/Power:220V/1000-2200W
 - 6 Induction cooker module
Size:450*800*H180MM
Voltage/Power:220V/1000-2200W
 - 7 Soup module
Size:450*800*H180MM
Voltage/Power:220V/1000W
 - 8 Noodle cooking module
Size:450*800*H180MM
Voltage/Power:220V/2000W
 - 9 Sauce warmer module
Size:450*800*H180MM
Voltage/Power:220V/1000W
 - 1 Ice bin module
Size:450*800*H180MM
Code:TKING-BS.01.11
Voltage/Power:220V/200W
 - 2 Electric deep frying module
Size:450*800*H180MM
Voltage/Power:220V/2500W

- 1/3**
- 1 Flat module
Size:600*800*H20MM
 - 2 Ice bin module
Size:600*800*H180MM
Voltage/Power:220V/200W
 - 3 Dim sum module
Size:600*800*H180MM
Voltage/Power:220V/2000W
 - 4 Soup module
Size:600*800*H180MM
Voltage/Power:220V/1000W
 - 5 Noodle cooking module
Size:600*800*H180MM
Voltage/Power:220V/2000W
 - 6 Sauce warmer module
Size:600*800*H180MM
Voltage/Power:220V/1000W
 - 7 Induction wok module
Size:600*800*H180MM
Voltage/Power:220V/2000W
 - 8 Induction cooker module
Size:600*800*H180MM
Voltage/Power:220V/1000-2200W
 - 9 Electric deep frying module
Size:600*800*H180MM
Voltage/Power:220V/2500W

- 1/2**
- 1 Flat module
Size:900*800*H20MM
 - 2 Ice bin module
Size:900*800*H180MM
Voltage/Power:220V/200W
 - 3 Carving station
Size:900*800*H20MM
 - 4 Roast meat station
Size:900*800*H1220MM
Voltage/Power:220V/575W
 - 5 Griddle module
Size:900*800*H180MM
Voltage/Power:220V/2000W

- 1/1**
- 1 Flat module
Size:1800*800*H20MM
 - 2 Electric heat board module
Size:1800*800*H180MM
Voltage/Power:220V/600W
 - 3 Ark of sushi
Size:1200*385*H385MM
Voltage/Power:220V/500W



| Oak pattern |



| Walnut pattern |



| Oak pattern |



| Teak pattern |



| Pine pattern |



| Willow pattern |



ELEGANT AMBIENCE

Contracted and easy, without excessive adornment, and encumbrous contracted and comfortable, pure and fresh and subtly elegant.



DCS TK-BS01-72
Module trolley
900 x 950 x H1880

DCS TK-BS01-80
Panel trolley
730 x 875 x H2000

DCS TK-BS01-76
Folding rack middle panel
trolley (small size)
1300 x 950 x H2050

DCS TK-BS01-78
Folding rack middle panel
trolley (large size)
1750 x 1160 x H2050



CONCISE AND COMFORTABLE

Contracted and easy, without excessive adornment and encumbrance, contracted and comfortable, fresh and quietly elegant.



白色的雅致 黑色的



DCS 20D8830
Live Cooking table
(L)1200 x (W)900 x (H)900
Material: Wood, Stainless Steel



DCS 20D8831-100
Live Cooking table
(L)1820 x (W)750 x (H)925
Material: Wood, Stainless Steel



DCS 20D8831
Live Cooking table
(L)910 x (W)750 x (H)900
Material: Wood, Stainless Steel



DCS 20D8835-3
Live Cooking table
(L)720 x (W)710 x (H)750
Material: Wood, Stainless Steel

DCS 20D8835-2
Live Cooking table
(L)970 x (W)710 x (H)900
Material: Wood, Stainless Steel

DCS 20D8835-1
Live Cooking table
(L) 1220 x (W) 720 x (H) 1050
Material: Wood, Stainless Steel



DCS 20D8833
Live Cooking table
(L)1500 x (W)750 x (H)900
Material: Wood, Stainless Steel



DCS 20D9900
Mobile Buffet Cube with LED
(L)800 x (W)800 x (H)800
(L)800 x (W)800 x (H)900



패밀리 레스토랑 샐러드바
Family Restaurant Salad Bar
좌석수: 130 석



핫스테이션 (즉석코너)

인덕션렌지나 전기히터를 매립하여 한식, 중식, 양식등의 따뜻한 음식을 구성할 수 있도록한 부페스테이션입니다.



콜스테이션 (샐러드바)

냉장장치를 설치한 아이스빈을 매립하여 다양한 종류의 샐러드를 세팅할 수 있으며 음식의 종류에 따라 다양한 형태의 샐러드바를 구성할 수도 있습니다.



샤브야채 가슴 스테이션

가슴장치를 내부에 설치해서 샤브채소의 신선도를 높이는 부페스테이션입니다.



음료 & 디저트 스테이션

일반적으로 펄스스테이션으로 구성되어 다양한 음료장비를 셋팅할 수 있으며 디저트용 아이스베드나 아이스크림 냉동고 매립도 가능합니다.



M 샐러드바



"Our design can keep the fresh on the salad table."

테이블형 샐러드바



채선당 자연한그릇 광명점





Family Salad Bar (패밀리 샐러드 바)

Large

(L)3220×(W)1160×(H)850~1540

Medium

(L)2620×(W)1000×(H)850~1540

Small

(L)2280×(W)1000×(H)850~1540



Italian Salad Bar (이탈리안 샐러드 바)

Large

(L)4200×(W)1200×(H)850~2050

Medium

(L)3000×(W)1200×(H)850~2050



Salad Bar (샐러드 바)

(L)3600×(W)1300×(H)850



DCS 20D9907
Mobile Salad Station
(L)1800 x (W)750 x (H)850



DCS 20D9910
Mobile Salad Station
(L)1200 x (W)700 x (H)850 (1425)



DCS 20D9911
Mobile Salad Station
(L)1600 x (W)650 x (H)850 (1430)



DCS 20D9912
Mobile Salad Station
(L)1600 x (W)650 x (H)850 (1430)



DCS 20D9905
Salad Station
(L)2400 x (W)800 x (H)850~1150



DCS 20D9908
Salad Station
(L)2400 x (W)800 x (H)850~1150



샐러드 스테이션



핫 스테이션



이동식 뷔페 스테이션 2-1



이동식 뷔페 스테이션 2-2



이동식 뷔페 스테이션 2-3

아이스베드(샐러드, 스시, 콜디쉬) 시스템



뷔페스테이션용 아이스베드

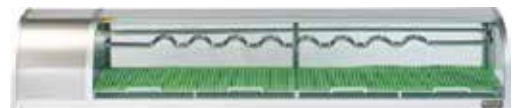

Sushi Show Case

Model	Size (L x W x H)
DCS21D5502-C09	(L)900×(W)304×(H)284 mm
DCS21D5502-C12	(L)1200×(W)304×(H)284 mm
DCS21D5502-C15	(L)1500×(W)304×(H)284 mm
DCS21D5502-C18	(L)1800×(W)304×(H)284 mm



"The dinning ware on the station that applied induction, can keep warm condition of food."

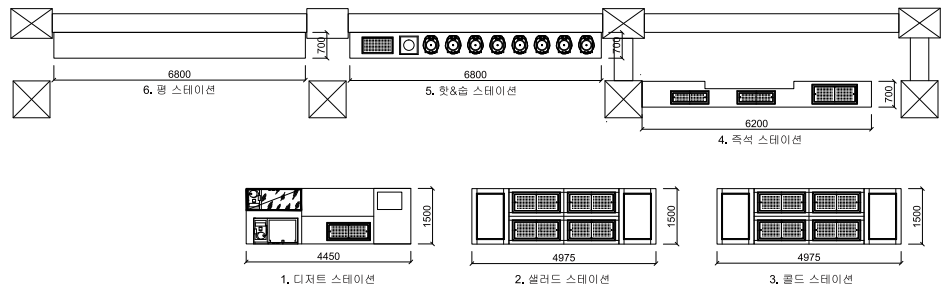

1 DCS20D9920

디저트 스테이션
Size: (L)3450 x (W)1500 x (H)950 mm

2 DCS20D9921

샐러드 스테이션
Size: (L)4975 x (W)1500 x (H)850 mm

3 DCS20D9922

콜드 스테이션
Size: (L) 4975 x (W) 1500 x (H) 850 mm

4 DCS20D9923

즉석 스테이션
Size: (L)6199 x (W)700 x (H)900 mm

5 DCS20D9924

핫&습 스테이션
Size: (L)6798 x (W)700 x (H)900 mm

6 DCS20D9925

평스테인
Size: (L)6798 x (W)700 x (H)900 mm



DCS 20D9932 (2斗)
Ice bed
(L)732 x (W)607 x (H)560
Hole Size: (L)718 x (W)593 mm

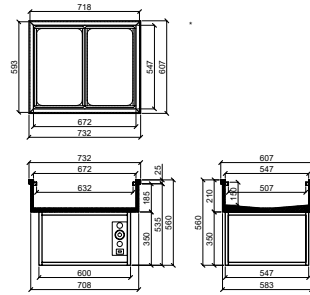

DCS 20D9933 (3斗)
Ice bed
(L)1063 x (W)607 x (H)560
Hole Size: (L)1049 x (W)593 mm

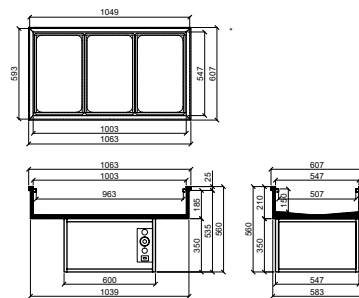

DCS 20D9934 (4斗)
Ice bed
(L)1394 x (W)607 x (H)560
Hole Size: (L)1380 x (W)593 mm

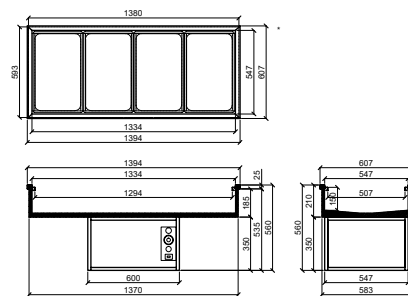



DCS 21D5501
Mobile Multi Bar Station
(L)1500 x (W)1000 x (H)1900



DCS 20D9900-001
Mobile Multi Bar Station
(L)2000 x (W)700 x (H)850(1800)



DCS 20D9900-002
Mobile Multi Bar Station
(L)2000 x (W)700 x (H)850 (1800)



DCS 21D5502
Sushi Service Station
(L)1800 x (W)800 x (H)2100



DCS 21D5503
Food Display Station
(L)1930 x (W)1060 x (H)1100



DCS 21D5504
Sushi Service Station
(L)1800 x (W)800 x (H)2100



DCS BCD1120-001
이동식 판매대



DCS GE-BA11S
Plate Warmer Dispenser (2구)
(L)950 x (W)530 x (H)1030



DCS GE-WT02S
Plate Warmer Dispenser (1구)
(L)450 x (W)450 x (H) 850
(Electric Heater Plate Warming)



DCS GE-WT03R
Plate Warmer Dispenser (1구)
(L)450 x (W)450 x (H) 850
(Electric Heater Plate Warming)



DCS 22D3370
Barbecue Trolley
(L)1100 (1500) x (W)650 (850) x (H)930



DCS 22D3380
Teppanyaki Trolley - 주문제작
(L)1100 x (W)650 x (H)1050
Material: Stainless Steel



DCS 22D3371
Barbecue Trolley
(L)1200 x (W)600 (850) x (H)905



DCS 22D3372
Barbecue Trolley
(L)1200 x (W)600 (850) x (H)905





DCS 21D0016
라운드 쇼케이스
(L)1800 x (W) 800 x (H)1250



DCS 21D0055
아이스크림 쇼케이스
(L)1200 x (W)1050 x (H)1350



DCS 21D0035
사각 쇼케이스
(L)1800 x (W)750 x (H)1550



DCS 21D0016
사각 쇼케이스
(L)2000 x (W)750 x (H)1400



DCS BC06HR
포장마차
(L)2485 x (W)1354 x (H)2680



DCS BC12
포장마차
(L)2485 x (W)1354 x (H)2700





DCS TK-DC08-02
Multi-function display cart
2700 x 800 x H920/2100



DCS TK-DC08-01
Multi-function display cart
2500 x 800 x H920/2100



MODERN SIMPLICITY, INTERPRETATION
OF THE ESSENCE OF FASHION



DCS TK-DC09-01
Multi-function display cart
2000 x 900 x H2000



DCS TK-DC02-01
Drinks display cart
1600 x 800 x H2150



DCS TK-DC02-02
Induction cooker display cart
1600 x 800 x H2150



DCS 20D880P-003
Display Wagon
1420 x 630 x H810

Portable Sneeze Guard

특 허 : 제 10-2243612
 특 허 : 제 10-2224904
 디자인 : 제 30-2094887
 디자인 : 제 30-1090775



| 제품의 특징 |

1. 포터블 스타일 (Portable style)

- 설치작업 없이 푸드스테이션 위에 즉시 사용할 수 있습니다
- 쉽게 옮길 수 있어서 위치변경이 자유롭습니다.

2. 접이식 스타일 (Foldable style)

- 보관과 운반이 편하여 연회장과 출장뷔페에서도 사용하기 용이합니다.
- 전용카트를 사용하시면 운반과 보관이 훨씬 쉬워집니다.

3. 가드의 높이와 각도조절 가능

- 높이와 각도를 조절할 수 있어서 손쉽게 메뉴에 맞춰 사용할 수 있습니다.

4. 크리스탈 강화글라스 사용 (Tempered Crystal Clear Glass)

- 음식의 맛과 신선함을 생생하게 느낄 수 있도록 크리스탈 유리를 사용했습니다.
- 강화글라스로 충격에 강하고 쉽게 깨지지 않아서 안전합니다.

5. 글라스 조립 (Non-실리콘)

- 글라스 조립에 실리콘을 사용하지 않습니다.
- 실리콘에 의한 곰팡이 걱정이 없고, 청결관리가 쉬우며, 유리 교체가 간편합니다.

6. 2단선반으로도 활용이 가능하여 다양한 용도로 사용 할 수 있습니다.



Portable Sneeze Guard

PRODUCT SPECIFICATION

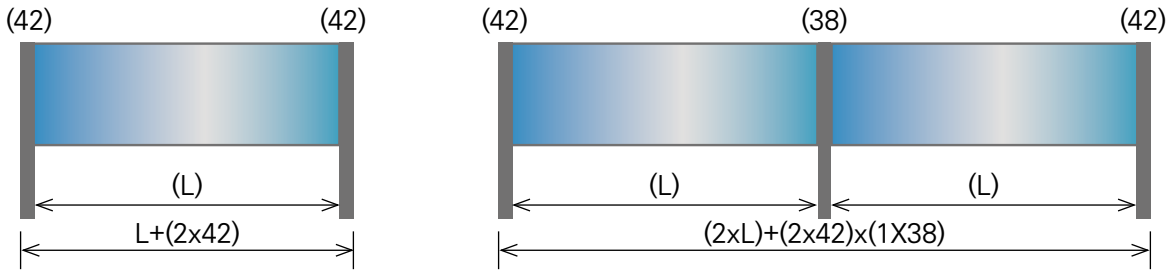
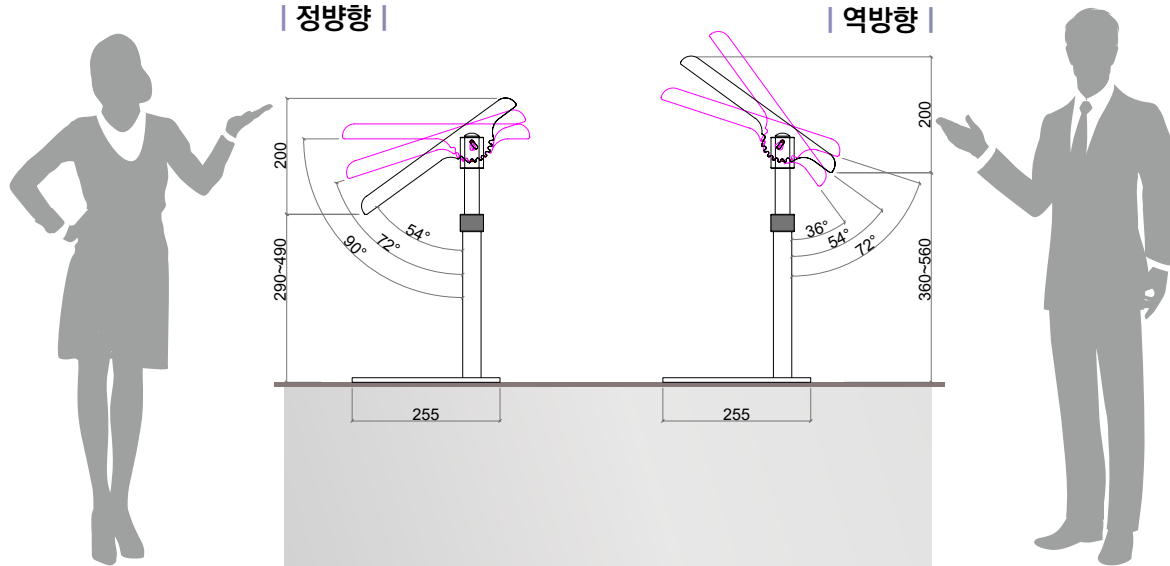

독립형 기본규격

제품번호 (Model no)	가드길이 (폭) 300 (mm)	길이 Length / mm		정방향 높이 Height (mm)		역방향 높이 Height (mm)	
		Inside	Overall	기본	확장	기본	확장
DCS 0900	900	894	984	490	690	560	760
DCS 1200	1200	1195	1285	490	690	560	760
DCS 1500	1500	1495	1685	490	690	560	760

연결형 설치길이 : 상설뷔페의 경우 연결형으로 설치하면 비용을 절약할 수 있습니다.

제품번호 (Model no)	Length (mm)				
	2단	3단	4단	5단	6단
DCS 0900	1922	2860	3798	4736	5674
DCS 1200	2522	3760	4998	6236	7474
DCS 1500	2822	4060	5298	6536	7974

- 설치 길이 계산공식: (가드의 길이 x 개수) + 84 (양끝 기둥 두께) + (중간기둥 개수 x 38)
- 고객의 요구에 따라서 기본규격 이외의 규격으로도 주문제작이 가능합니다.



Creation & Service

Kitchen & Catering Equipment

HOTEL SPECIALTY



CONTENTS

Kitchen & Catering Equipment

108-111
Banquet Trolley

113
Shelf Trolleys

115
Glass Racks & Carts

118
단체식당용 자물배식대

112
Rack Carts

114
Adjustable Dish Caddy

116
Work Tables & Cabinets

119
단체급식 배식대 납품사례

Banquet Warmer Cart / Single Door DCS 22D6622



팬 규격	GN 2/1 20 x 530 x 650 x 20		AL-C Pan 30 x 460 x 650	
	모델번호	BWT01-G21H	BWT01-G21M	BWT01-A46H
외경규격 Overall size	795 x 870 x 1912	795 x 870 x 1450	725 x 870 x 1912	725*870*1450
내경 Inside	540 x 650 x 1450	540 x 650 x 1078	470 x 650 x 1450	470 x 650 x 1078
팬 간격	간격조절식 기본간격 30mm 최저간격 60mm	간격조절식 기본간격 30mm 최저간격 60mm	간격조절식 기본간격 30mm 최저간격 60mm	간격조절식 기본간격 30mm 최저간격 60mm
단수 홀간격 30mm	60mm = 24단 90mm = 15단	60mm = 18단 90mm = 12단	60mm = 24단 90mm = 15단	60mm = 18단 90mm = 12단
기본사양 Temperature	1.5kw/H Max 70°C	1.5kw/H Max 70°C	1.5kw/H Max 70°C	1.5kw/H Max 70°C
추가사양 Temperature	2.5kw/H Max 85°C	2.5kw/H Max 85°C	2.5kw/H Max 85°C	2.5kw/H Max 85°C
중량	170kg	120kg	165kg	115kg

※ 제품의 규격과 전기용량, 중량 등은 품질개선으로 사전 예고없이 변경될 수 있음.

대원 C&S의 Banquet Warmer Cart는 KC인증을 받은 제품으로 본체의 내·외부 모두 스테인레스 304재질로 제작합니다.

열순환식 구조로 내부의 온도 편차를 최소화 시켰고,

디지털 온도컨트롤러와 센서를 부착하여 온도를 정밀하게 조절할 수 있습니다.

실리콘히터를 사용하여 반영구적이고, 전력소모량이 적으며,

40mm 두께의 난연성 KS 카이론단열재를 사용하여 열효율이 높습니다.

Banquet Warmer Cart / Double Door DCS 22D6622-001

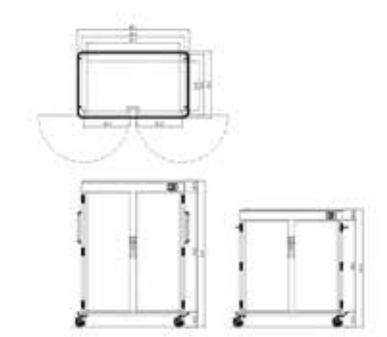

팬 규격	GN 2/1 20 x 530 x 650 x 20	
모델번호	BWT02-G21H	BWT02-G21M
외경규격 Overall size	1500 x 870 x 1912	1500 x 870 x 1450
내경 Inside	1245 x 650 x 1450 1260L	1245 x 650 x 1078 940L
팬 간격	간격조절식 기본간격 30mm 최저간격 60mm	간격조절식 기본간격 30mm 최저간격 60mm
단수 홀간격 30mm	60mm = 24단 90mm = 15단	60mm = 18단 90mm = 12단
기본사양 Temperature	1.5kw/H Max 70°C	1.5kw/H Max 70°C
추가사양 Temperature	2.5kw/H Max 85°C	2.5kw/H Max 85°C
중량	238kg	166kg

※ 제품의 규격과 전기용량, 중량 등은 품질개선으로 사전 예고없이 변경될 수 있음.

6인치 중하중용 저소음 바퀴를 장착하여 소음이 없고 이동이 편합니다.
접시보온용으로 사용시, 스테인레스 와이어헬프를 선택하실 수 있습니다.
카트전문 대원씨앤에스에서 직접 국내제작하고 AS를 책임집니다.
고객사에서 원하는 규격과 사양으로 주문제작도 가능합니다.



Banquet Cold Cart / Single Door DCS 22D6623

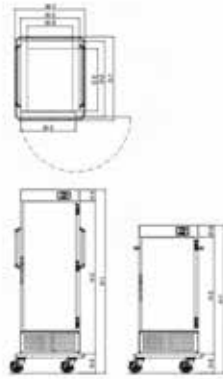

※ 결로방지 열선 내장

팬 규격	GN 2/1 20 x 530 x 650 x 20		AL-C Pan 30 x 460 x 650	
	모델번호	BCT01-G21H	BCT01-G21M	BCT01-A46H
외경규격 Overall size	795 x 870 x 1912	795 x 870 x 1450	725 x 870 x 1912	725 x 870 x 1450
내경 Inside	540 x 650 x 1188 580L	540 x 650 x 816 430L	470 x 650 x 1188 580L	470 x 650 x 816 430L
팬 간격	간격조절식 기본간격 30mm 최저간격 60mm	간격조절식 기본간격 30mm 최저간격 60mm	간격조절식 기본간격 30mm 최저간격 60mm	간격조절식 기본간격 30mm 최저간격 60mm
단수 홀간격 30mm	60mm = 24단 90mm = 15단	60mm = 18단 90mm = 12단	60mm = 24단 90mm = 15단	60mm = 18단 90mm = 12단
기본사양 Temperature	1/3HP 0.5kw/H	1/3HP 0.5kw/H	1/3HP 0.5kw/H	1/3HP 0.5kw/H
추가사양 Temperature	0℃	0℃	0℃	0℃
중량	210kg	143kg	205kg	140kg

※ 제품의 규격과 전기용량, 중량 등은 품질개선으로 사전 예고없이 변경될 수 있음.

국산 LG 컴프레샤와 친환경 신냉매가스를 사용하며 열선을 설치하여 결로를 방지합니다.

사용팬의 종류는 스테인레스 GN팬 2/1 규격과 알루미늄 C팬 460 x 650, 스테인레스 와이어셴틀을 선택하실 수 있습니다.

카트전문 대원씨앤에스에서 직접 국내제작하고 AS를 책임집니다.

고객사에서 원하는 규격과 사양으로 주문제작도 가능합니다.

Banquet Cold Cart / Double Door DCS 22D6623-001

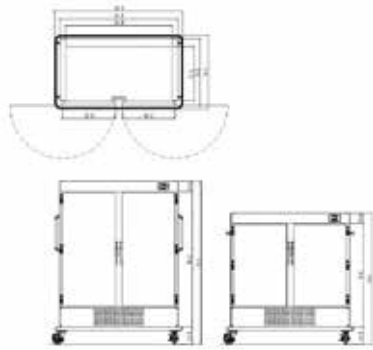

※ 결로방지 열선 내장

팬 규격	GN 2/1 20 x 530 x 650 x 20	
모델번호	BCT02-G21H	BCT02-G21M
외경규격 Overall size	1500 x 870 x 1912	1500 x 870 x 1450
내경 Inside	1245 x 650 x 1188 1040L	1245 x 650 x 1078 715L
팬 간격	간격조절식 기본간격 30mm 최저간격 60mm	간격조절식 기본간격 30mm 최저간격 60mm
단수 홀간격 30mm	60mm = 18단 90mm = 12단	60mm = 12단 90mm = 8단
기본사양 Temperature	1/3HP 0.6kw/H	1/3HP 0.6kw/H
추가사양 Temperature	0℃	0℃
중량	298kg	226kg

※ 제품의 규격과 전기용량, 중량 등은 품질개선으로 사전 예고없이 변경될 수 있음.



GN Pan 2/1
650 x 530



Alluminume C-Pan
460 x 650



Stainless wire rack
650 x 530

※ 팬은 별매임



DCS 22D1172
Dish Rack Cart-2 Tiers
(L)580 x (W)580 x (H)1750
104 dishes Load and unload from 4 sides
Material : Powder Coated Steel
Pipe Structure 4" swivel casters



DCS 22D1172-100
Dish Rack Cart-2 Tier PU Cover



DCS 22D1171
Dish Rack Cart-1 Tiers
(L)580 x (W)580 x (H)1000
52 dishes Load and unload from 4 sides
Material : Powder Coated Steel
Pipe Structure 4" swivel casters



DCS 22D1171-100
Dish Rack Cart-1 Tier PU Cover



DCS 22D1101
Tray Rack Cart-15
(L)690 x (W)495 x (H)1800
Material: Stainless Steel



DCS 22D1105
Tray Rack Cart-10
(L)690 x (W)495 x (H)1275
Material: Stainless Steel



DCS 22D1114
Tray Rack Cart-10
(L)690 x (W)495 x (H)1275
Material: Stainless Steel



DCS 22D1102
Tray Rack Cart-15
(L)690 x (W)495 x (H)1800
Material: Stainless Steel



DCS 22D1103
Kitchen Trolley-5
(L)690 x (W)495 x (H)1100
Material: Stainless Steel Pipe & Aluminum Tray



DCS 22D1108
Tray Rack Cart (Double)
(L)770 x (W)510 x (H)1600
Material: Stainless Steel



DCS 22D1115-000
Oven Tray Rack Cart
(L)500 x (W)706 x (H)1700 mm
Material: Stainless Steel



DCS 22D3301
Shelf Trolley-1
(L)850 x (W)510 x (H)850
Material: Stainless Steel



DCS 22D3303
Shelf Trolley-3
(L)850 x (W)510 x (H)850
Material: Stainless Steel



DCS 22D3304
Shelf Trolley-4
(L)850 x (W)510 x (H)1050
Material: Stainless Steel



DCS 22D3322
Stainless Cart-2
(L)1200 x (W)600 x (H)1120
Material: Stainless Steel



DCS 22D3323
Stainless Cart-3
(L)1200 x (W)600 x (H)1120
Material: Stainless Steel



DCS 22D3306
Dining Room Trolley
(L)900 x (W)550 x (H)1120
Material: Stainless Steel



DCS 22D3305
Shelf Trolley-5
(L)1280 x (W)670 x (H)1500
Material: Stainless Steel



DCS 22D3308
Bussing Cart
(L)850 x (W)455 x (H)935
Material: Stainless Steel



DCS 22D3309
Bussing Cart (A)
(L)1000 x (W)500 x (H)930
Material: Stainless Steel



DCS 22D3313
Heavy Duty Trolley
(L)1100 x (W)650x (H)870
Material: Stainless Steel



DCS 22D3311
Baggage Cart
(L)1050 x (W)600 x (H)900
Material: Stainless Steel



DCS 24D2201
Baggage Cart
(L)1050 x (W)600 x (H)900
Material: Stainless Steel



DCS 22D3351
Cleaning Tank Trolley
(L)650 x (W)560 x (H)720
Material: Stainless Steel



DCS ADDCCS0-002
DCS ADDCCS0-002 can hold 4.5"-13" plates, trays and dishes
Maximum 6 dividers, 8 stacks, and 400 pcs
1090 x 720 x 800



DCS ADDCCS0-001
DCS ADDCCS0-001 can hold 4.5"-13" plates, trays and dishes
Maximum 6 dividers, 6 stacks, and 300 pcs
960 x 860 x 756



DCS ADDCCS0-003
DCS ADDCCS0-003 can hold 4.5"-13" plates, trays and dishes
Maximum 4 dividers, 4 stacks, and 200 pcs
900 x 725 x 805



DCS ADDCCS0-002
Stockable Plate Size

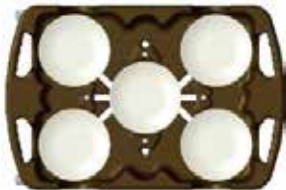

DCS ADDCCS0-002
Layout for 9-4/5" to 11-1/4" plates

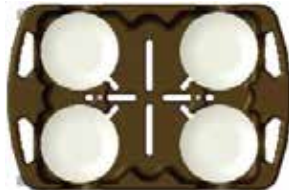

DCS ADDCCS0-002
Layout for 11-2/5" to 13" plates and 13-1/2" by 10-1/2" plates

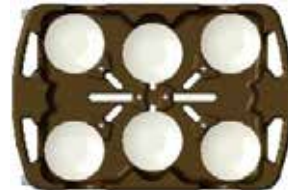

DCS ADDCCS0-002
Layout for 8-2/5" to 8-4/5" plates

DCS ADDCCS0-001
Stockable Plate Size



DCS ADDCCS0-001
Layout for 7" to 9" plates and 5-1/2" to 7" and 4-1/2" plates



DCS ADDCCS0-001
Layout for 9" to 13" plates and 5" plates



DCS ADDCCS0-001
Layout for 5-1/2" to 7" plates

DCS ADDCCS0-003
Stockable Plate Size



DCS ADDCCS0-003
Layout for 6" to 13" plates



DCS ADDCCS0-003
Layout for 4-1/2" to 6" plates



DCS 41D1121
Cutlery Rack
500 x 500 x (H)100



DCS 41D1122
Plate Rack
500 x 500 x (H)100



DCS 41D1116
Glass Rack -16
500 x 500 x (H)100



DCS 41D1120
Glass Rack -20
500 x 500 x (H)100



DCS 41D1125
Glass Rack -25
500 x 500 x (H)100



DCS 41D1136
Glass Rack -36
500 x 500 x (H)100 (88)



DCS 41D1122-014
Open Extender
500 x 500 x (H)400



DCS 41D1116-100
Extender -16
500 x 500 x (H)40



DCS 41D1125-100
Extender -25
500 x 500 x (H)40



DCS 41D1136-100
Extender -36
500 x 500 x (H)40



DCS 22D2210
Glass Rack Trolley-Stainless
560 x 560 x (H)870



DCS WSD2200-101
Glass Rack Trolley-Plastic
535 x 535 x (H)910





DCS GZT-SCDT
Work Table with 3 Drawers and 2 Sliding Doors
(L)1800 x (W)800 x (H)800



DCS GZT-ST
Modular work table with Singles Sliding Door
(L)1800 x (W)800 x (H)800
(L)2000 x (W)800 x (H)800



DCS SCPBGZT
Work Table with 2 Undershelf
(L)1800 x (W)800 x (H)800



DCS GZT-SC
Work Table with Undershelf
(L)1800 x (W)800 x (H)800
(L)1500 x (W)800 x (H)800



CWG-SM
Sliding Doors Cabinet
(L)1200 x (W)500 x (H)1800
(L)1000 x (W)500 x (H)1800



LMDG
Sliding Doors Cabinet
(L)1200 x (W)400 x (H)660



ZZSCCKHJ
Four Tier Standing Shelving Unit with Vented Shelves
(L)1200 x (W)500 x (H)1800
(L)1200 x (W)500 x (H)1550



ZZSCPBHJ
Four Tier Standing Modular Shelving-A
(L)1200 x (W)500 x (H)1800
(L)1200 x (W)500 x (H)1550



"Our self-serve table can supply to various meal as different taste customer's choice."

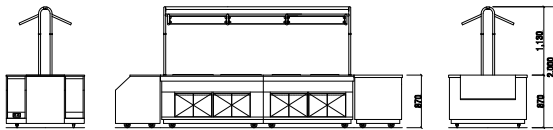
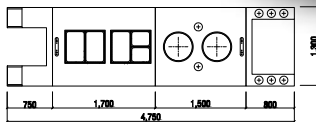

제품번호	모델명	규격 (mm)	구성
DCS 00D7700	자율 배식대 (기본형)	(L)4750 x (W)1300 x (H)870~2000	1. 식판/수저배분대 2. 국배식대 3. 밥(보온), 배식대(보온 2ea) 4. 핫 디쉬 배식대(보온 2ea), 콜 디쉬 배식대(보온 2ea), 스니즈 가드

"Our self-serve table creates much luxurious atmosphere by applying marble pattern."



제품번호	모델명	규격 (mm)	고급형	일반형	일반형 옵션
1	식판/수저배분대	(L)800x(W)1300x(H)870 mm			
2	국 배식대	(L)750x(W)1300x(H)870 mm	상판 : 인조대리석	상판 : 스텐	상판 : 인조대리석
3	밥(보온), 배식대(보온 2ea)	(L)1500 x (W)1300 x (H)870~2000			
4	핫 디쉬 배식대 & 콜 디쉬 배식대	(L)1700 x (W)1300 x (H)870~2000	본체 : 목재 /무늬목 도장	본체 : 스텐	본체 : 시트지

"The body coated by wood & veneer pattern."

여닝지붕형 배식대

(L)4700 x (W)1300 x (H)800~2100



마차형 배식대

(L)2700 x (W)700 x (H)700~2100

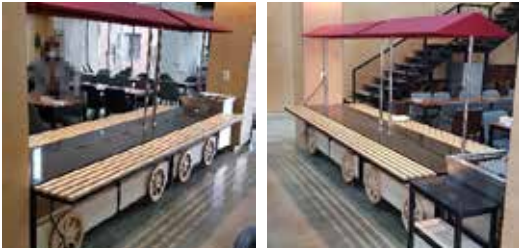

프리미엄 배식대

(L)4000 x (W)1300 x (H)800



테이블형 배식대

(L)4200 x (W)1200 x (H)800



유리선반 일자형 배식대

(L)1500 x (W)1200 x (H)800
(L)2500 x (W)1200 x (H)800



Creation & Service

Buffet Wares

HOTEL SPECIALTY



CONTENTS

Buffet Wares

122 Wet(Dry) Electric Heating Chafing Dish	123 Modern Induction Chafing Dish
124 Ordinary Induction Chafing Dish	125 Roll Top Chafing Dish with strackerble Stand
126 Mini Induction Chafing Pot	127 Gravy server & Small soup urn Induction & Heating & Cooling Stand
127 Pots and Pans	128 Coffee Urn
128 Dispenser	129 Hollow Ware
130 Heating Lamp & Carving Stand	131 Decorative Heated Lamps
132 Carving Station	133 Drop-in Heated Shelve With Stainless Steel Frame
134-135 Coffee & Tea	136 - 139 Flatware
140 - 141 Bread Displays	142 Fruits And Salad Displays
143 - 145 Dessert Displays	146 Buffet Riser
147 Tea Stands	148 Cold Displays
149 Ice Buckets	



DCS 15D88011UL (1/1)
Rectangular Chafing Dish
(L)576 x (W)467 x (H)213 / 13 Liter



DCS 15D88032UL (2/3)
Square Chafing Dish (GN 2/3)
(L)400 x (W)467 x (H)213 / 8 Liter



DCS 15D88021UL (1/2)
Square Chafing Dish (GN 2/3)
(L)312 x (W)467 x (H)213 / 6 Liter

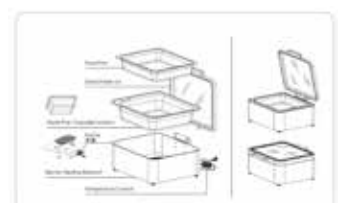

DCS 15D88011UL Wet (Dry)
Electric Chafing Dish



DCS 15D8060
Round Chafing Dish
(L)442 x (W)538 x (H)213 / 8 Liter



DCS 15D8040UL
Round Chafing Dish
(L)372 x (W)465 x (H)213/6 Liter

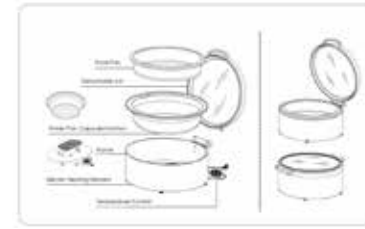

DCS 15D8040UL Wet (Dry)
Electric Chafing Dish

※ 습식용 도자기팬 별도



DCS 15D80-11UL
Round Soup station / 11 Liter
(L)372 x (W)465 x (H)305 / 11 Liter

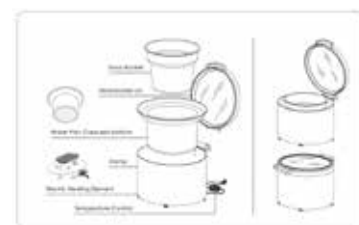

DCS 15D80-11UL Wet (Dry)
Electric Chafing Dish





STS 304 Water Pan

Capsuled Bottom to react on the induction stove

Lid Position

Open up to Maximum 90° Stays Open at 70° to 90°
Initiate to Close by pressing down gently Open cover easily and effortlessly

Water return system

condensation flows back to water pan instead of food

Notch

changing food pan easily

Hydraulic dramping hinge



Stackable stand



Transport cart



Rectangular Chafing Dish (GN 1/1)



DCS 15D88011TLS (1/1)

(L)575 x (W)466 x (H)180 / 9 Liter



DCS 15D88011F (1/1)

(L)595 x (W)390 x (H)205



Square Chafing Dish (GN 2/3)

Square Chafing Dish (GN 1/2)



DCS 15D88032TLS (2/3)

(L)400 x (W)465 x (H)160/6 Liter

DCS 15D88021TLS (1/2)

(L)310 x (W)465 x (H)160/4 Liter



DCS 15D88032F (2/3)

(L)420 x (W)390 x (H)205

DCS 15D88021F (1/2)

(L)330 x (W)390 x (H)205



Round Chafing Dish

Large 6 Liter / Medium 4 Liter



DCS 15D88060TLS

(L)440 x (W)535 x (H)165/6 Liter

DCS 15D88040TLS

(L)370 x (W)460 x (H)165/4 Liter



DCS 15D88060F

(L)490 x (W)490 x (H)205

DCS 15D88040F

(L)420 x (W)420 x (H)205



Round Soup station / 11Liter



DCS 15D880-11TLS

(L)460 x (W)450 x (H)265 / 11 Liter



DCS 15D880-11F

(L)420 x (W)420 x (H)205



Lid Position

Open up to Maximum 90° Stays Open at 70° to 90° Initiate to Close by pressing down gently
Open cover easily and effortlessly

Water return system condensation flows back to water pan instead of food

Damping Cover Design

Open Cover easily and effortlessly

Mirror polished STS 201 Water pan

Capsuled Bottom to react on the induction stove fast & even heating

Adjustable Level support

for a perfectly level placement

Insert Lifting pin

To change the food pan easily



Stackable stand



Rectangular Chafing Dish

Hammered stainless Lid & stackerble stand (GN 1/1)



DCS 15D11011LD

(L)590 x (W)410 x (H)203 / 9 Liter



DCS 15D11011DF

Stackable stand (1/1)
(L)575 x (W)375 x (H)222



Rectangular Chafing Dish

Hammered stainless Lid & stackerble stand (GN 1/1)



DCS 15D11060LD

(L)520 x (W)445 x (H)210 / 6 Liter



DCS15D11060DF

(L)445 x (W)445 x (H)222



Square Chafing Dish

Stainless Lid & Stackable stand
GN 2/3 / GN 1/2



DCS 15D11032LD (GN 2/3)

(L)415 x (W)410 x (H)195 / 6 Liter



DCS 15D11032DF (2/3)

(L)396 x (W)372 x (H)222



DCS 15D10-11LD

(L)410 x (W)410 x (H)290



DCS 15D10-11LD

(L)495 x (W)470 x (H)325 / 11Liter



DCS 15D110-11DF

Stackable stand
(L)378 x (W)378 x (H)222

Roll Top Chafing Dish with strackerble Stand

Buffet Wares



YU15DYYH723D
Rectangular Chafing Dish
 (GN 1/1)
 (L)485 x (W)470 x (H)445 / 9 Liter



YU15DYYH736D
Oval Chafing Dish
 (L)650 x (W)550 x (H)465 / 6.8 Liter



Transport cart



YU15DYYH722D
Oblong Chafing Dish
 (L)485 x (W)470 x (H)445 / 6 Liter



YU15DYYH721D
Round Chafing Dish
 (L)475 x (W)520 x (H)465 / 6 Liter

YU15DYYH726D
Round Chafing Dish
 (L)410 x (W)380 x (H)370 / 3 Liter

Accessories for Chafing Dish

Buffet Wares

Pocelain food pan-Porcelain



(GN 1/1) 8 Liter
 (L)530 x (W) 325 x (H)62



(GN 2/3) 6 Liter
 (L)352 x (W) 325 x (H)65



(GN 1/2) 6 Liter
 (L)325 x (W)265 x (H)65



(GN 1/1) 8 Liter
 (L)530 x (W) 325 x (H)65



(GN 2/3) 6 Liter
 (L)352 x (W) 325 x (H)65



(GN 2/3) 6 Liter
 (L)325 x (W)265 x (H)65

Stainless steel Pot



(4 Liter x 2)
 (T)1.2 x 535 x 340
 (T)0.9 x 295 x 240 x 220



10 Liter
 (T)1.2 x 390 x 390 x 230
 (T)0.9 x 360 x 300 x 270



Fuel Holder
 (T)0.6 x 170 x 90 x 65



Porcelain Gravy Pot
 (Φ) 240 x 153 / 4 Liter
 (Φ) 300 x 153 / 4 Liter



Round Food pan
 (Φ) 385 x 65 / 6 Liter
 (Φ) 340 x 65 / 4 Liter



Round Food pan-Stainless steel
 (Φ) 390 / 6 Liter
 (Φ) 330 / 4 Liter



Electric Heater
 200 x 302
 220V, 700w/H



Induction Range
 Φ185 x 75 (700w/H)
 Φ245 x 65 (1000w/H)

Buffet Wares



Round Mini pot with Handle
4.0 Liter, Food Pan Φ 280
(L)393 x (W)382 x (H)168



Square Mini pot with Handle
4.0 Liter, Food pan 325 x 265 x 80
(L)325 x (W)408 x (H)165



Stackable stand for Round Mini Pot



Stackable stand for Square Mini Pot

Round Mini pot with Handle
4.5 Liter, Food Pan Φ 300
(L)417 x (W)405 x (H)168

Option

1. Glass Lid or Stainless Lid
2. Body : Stainless Mirror polishing or Hammerd
3. Stand : Fuel, Induction Range, Electric heater



Induction Stand



Induction range with Stand



Round food pan-Porcelain
(Φ) 315 x 90 / 4.5 Liter
(Φ) 295 x 90 / 4 Liter



Round Food pan-Stainless steel
(Φ) 300 x 80 / 4.5 Liter
(Φ) 280 x 80 / 4 Liter



Electric heater with Stand



D-300EL-GR (4.5Liter)
D-280EL-GR (4.0Liter)



D-300EL-RD (4.5Liter)
D-280EL-RD (4.0Liter)



D-295EL-GR (4.0Liter)



D-295EL-RD (4.0Liter)



D-300EL-BU (4.5Liter)
D-280EL-BU (4.0Liter)



D-300EL-Y (4.5Liter)
D-280EL-Y (4.0Liter)



D-295EL-BU (4.0Liter)



D-295EL-Y (4.0Liter)



D-300EL-BK (4.5Liter)
D-280EL-BK (4.5Liter)



D-300EL (4.5Liter)
D-280EL (4.0Liter)



D-295EL-BK (4.0Liter)



D-295EL (4.0Liter)

Gravy server & Small soup urn Induction & Heating & Cooling Stand

Buffet Wares



DCS 15D990-J40 / 4 Liter
Gravy Server
(L)240 x (W) 293 x (H)325



DCS 15D990-J6H / 6 Liter
Soup Station
(L)310 x (W) 342 x (H)330



DCS 15D990-3G / 3 x 10"
Steamer
(L)325 x (W) 267 x (H)495



DCS 15D110111D
/ 4 Liter x 2 pcs
(L)680 x (W) 380 x (H)340



DCS 15DSS8032F
+ **DCS 15DHL-C10K**
(L)400 x (W) 370 x (H)95



DCS 15DSS8011F
+ **DCS 15DHL-C10K**
(L)575 x (W) 370 x (H)95



DCS 15DSS8060F
+ **DCS 15DHL-C10K**
(L)465 x (W)465 x (H)95



DCS 15D990-J4F
(Φ) 240 x 153 / 4 Liter



DCS 15DLLP-RF24-6
(Φ) 240 x 153 / 4 Liter



DCS 11D1120D12
(L)370 x (W) 440 x (H)105



DCS 15DSS4011F
(L)580 x (W) 425 x (H)70



Pots and Pans

Buffet Wares



| 라바 원형 주물냄비 |



| 라바 직사각 주물팬(민자) |



| 라바 전골 주물냄비 |



| 라바 원형 퓨어 그릴팬 |

	라바 원형 주물냄비	라바 전골 주물냄비	라바 직사각 주물팬(민자)	라바 원형 퓨어 그릴팬
규격(cm)	14 / 16/ 18 / 32	24 / 28	22 x 30	26
용량(L)	0.76 / 1.33 / 1.66 / 9.86	2.47 / 3.51	2.54	1.36
재질	무쇠주물(에나멜코팅)			
색상	레드 / 그레이 / 매트블랙			

Buffet Wares

Coffee Urn with Classic Stand



DCS 15D44019
(L)360 x (W)283 x (H)570/19L

DCS 15D44012
(L)345 x (W)283 x (H)450/12L

Coffee Urn with Stackable Stand



DCS 15D22012
(L)364 x (W)364 x (H)460/12L

DCS 15D22019
(L)364 x (W)364 x (H)580/19L



Dispenser

Milk Dispenser



DCS 15D7706M60
(L)242 x (W)275 x (H)435/6L



DCS 15D660M6H0
(L)350 x (W)230 x (H)500/6L

Cereal Dispenser



DCS 15DCC01250
(L)350 x (W)230 x (H)880/5L



DCS 15DCC018-12W
(L)350 x (W)230 x (H)910/12L



DCS 15D1100P00
(L)345 x (W)250 x (H)660/9L



Square Juice Dispenser



DCS F1D99401-10
(L)270 x (W)200 x (H)550/10L



DCS F1D99401-10B
(L)270 x (W)200 x (H)550/10L

Juice Dispenser



DCS 15D1D00310
(L)270 x (W)360 x (H)590/8L



DCS 15DPP01580
(L)350 x (W)230 x (H)880/8L



PE37
Double Wall Oval Shape
Wine Cooler (for 2 bottles)
(L)320 x (W)215 x (H)230



37P
Wine Cooler Stand
(L)220 x (W)180 x (H)630



WCS135 including:
Double wall wine cooler set
(L)350 x (W)230 x (H)880mm/5



PE28 [for 1 bottle]
Wine Cooler
(dia)21 x (H)220

3P
Wine Cooler Stand
(dia)21 x (H)630mm

PE35 double wall wine cooler
(dia)23 x (H)510

PE33 [for 2 bottles]
Wine Cooler
(dia)24.9 x (H)213

28P
Wine Cooler Stand
(dia)19 x (H)630

135P wine cooler stand
(dia)23 x (H)510



WCS35 including:
Double Wall Wine Cooler Set
(L)350 x (W)230 x (H)500mm/6L



YU15DPP00-445
(Φ)445 x 320



YU15DPP00S445
(Φ)445 x 295



TP0806 / NTP0806
Oval Plate Cover
(L)215 x (W)165

PE35 double wall wine cooler
(dia)23 x (H)510

TP1511 / NTP1511
(L)396 x (W)290

35P wine cooler stand
Wine Cooler Stand
(L)450 x (W)450 x (H)690

YU15DPP00S335
(Φ)335 x 230

TP0907 / NTP0907
(L)237 x (W)179

TP1712 / NTP1712
(L)429 x (W)319

TP1208 / NTP1208
(L)314 x (W)219

TP1913 / NTP1913
(L)484 x (W)333

TP1410 / NTP1410
(L)365 x (W)254



PC108
Plate Cover
(dia)274 x (H)61(inner 269mm)



TPR06 / NTPR06 / TPR08
Round Dome Cover
(dia)168mm, (dia)203mm



JDT328
Oval Show Plate w/Stone
(L)240 x (W)200 x (H)25

PC118 / PC128
(dia)282 x (H)61(inner 278mm)
320 x (H)61(inner 314mm)

NTPR08 / TPR09 / NTPR09
(dia)203mm, (dia)240mm

TPR10 / NTPR10 / TPR11
Size: (dia)257mm, (dia)290mm



JDF318
Oval Show Plate w/Stone
(dia)215 x (H)25



JDT338
Square Show Plate
w/Stone
(L)205 x (W)205 x (H)20

PC138 / PC148
(dia)298 x (H)61(inner 290mm)
(dia)295 x (H)61(inner 286mm)

NTPR11 / TPR12 / NTPR12
(dia)290mm, (dia)302mm

PC158
(dia)309 x (H)68(inner 300mm)

TPR14 / NTPR14
(dia)360mm



DCS C-60 / CL-250
(L)433 x (W)475 x (H)870



DCSC-60GR / CL-250GR
(L)433 x (W)475 x (H)870



DCSC-60W / CL-250GR
(L)433 x (W)475 x (H)870



DCS 19D4417T05
Heating Lamp
(Φ)160 x 720



DCS 19D4417T06
Heating Lamp
(Φ)160 x 720



DCS 19D4417T07
Heating Lamp
(Φ)160 x 720



DCS 22D4417-019
Heating Lamp
(Φ)160 x 720

























DCS 22D4417-020
Heating Lamp
(Φ)160 x 720



DCS 22D4417-021
Heating Lamp
(Φ)160 x 720

Decorative Heated Lamp(Metal support rod) (높이 고정식 히팅 램프)

























Model	Diameter (mm)	Height (mm)	Voltage	Power	Color choices
HL-400-ML	180	320-2445	220V	250W	 
HL-500-ML	165	320-2445	220V	250W	 
HL-600-ML	175	320-2445	220V	250W	  
HL-700-ML	175	320-2445	220V	250W	  
HL-725-ML	240	320-2445	220V	250W	  
HL-750-ML	285	320-2445	220V	250W	  
HL-775-ML	265	320-2445	220V	250W	  
HL-800-ML	285	320-2445	220V	250W	  

The total height of the metal support rod lamp is: from the top of the ceiling to the bottom of the insulated lampshade, and the height can be customized.

Decorative Heated Lamp(Adjustable Height Of Metal Support Rod) (높낮이 조절식 히팅 램프)



Model	Diameter (mm)	Height (mm)	Voltage	Power	Color choices
HL-400-ST	180	650-1900	220V	250W	 
HL-500-ST	165	650-1900	220V	250W	 
HL-600-ST	175	650-1900	220V	250W	  
HL-700-ST	175	650-1900	220V	250W	  
HL-725-ST	240	650-1900	220V	250W	  
HL-750-ST	285	650-1900	220V	250W	  
HL-775-ST	265	650-1900	220V	250W	  
HL-800-ST	285	650-1900	220V	250W	  

It has a telescopic hanging rod design, which allows you to freely control the height in actual use.

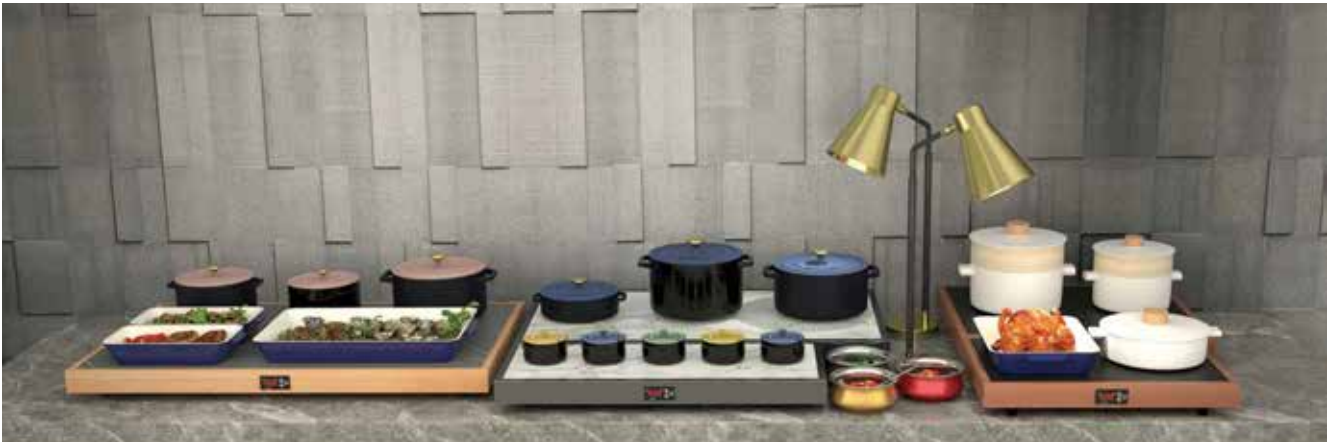

HOT DISH WITHOUT COVER



DCS 15D8801100(1/1)
(L)650 x (W)360 x (H)115 / 9 L



DCS 15D8803200(2/3)
(L)475 x (W)369 x (H)115 / 6 L



DCS 15D8806000
(L)515 x (W)435 x (H)115 / 6 L



DCS 15DCC00-32GR 상온식
(L)390 x (W)360 x (H)58



DCS 15DCC00-32 상온식
(L)390 x (W)360 x (H)58



DCS BW013 전기히터
(L)810 x (W)330 x (H)90



DCS BW016 전기히터
(L)600 x (W)400 x (H)90



DCS BW017 전기히터
(L)690 x (W)420 x (H)115 / 6 L



DCS BW015 전기히터
(L)1080 x (W)660 x (H)90



Hot plate / Built in style



Hot plate / Stand style



Glass top color

Size

Series	Model	Product Size (mm)	Hole Size (mm)	Power	Voltage
매립형 Microcrystal glass (Stainless steel frame) 300 series	TBIHG-65038	656 x 394 x 50	632 x 370	480W	220V/16A
	TBIHG-81038	811 x 394 x 50	787 x 370	650W	220V/16A
	TBIHG-96038	961 x 394 x 50	937 x 370	870W	220V/16A
	TBIHG-12638	1273 x 394 x 50	1249 x 370	960W	220V/16A
	TBIHG-15738	1583 x 394 x 50	1559 x 370	1300W	220V/16A
	TBIHG-18738	1883 x 394 x 50	1859 x 370	1740W	220V/16A
스탠드형 Imitation stone (Stainless steel frame) 300 series	TBIHS-65038	656 x 394 x 50	632 x 370	480W	220V/16A
	TBIHS-81038	811 x 394 x 50	787 x 370	650W	220V/16A
	TBIHS-96038	961 x 394 x 50	937 x 370	870W	220V/16A
	TBIHS-12638	1273 x 394 x 50	1249 x 370	960W	220V/16A
	TBIHS-15738	1583 x 394 x 50	1559 x 370	1300W	220V/16A
	TBIHS-18738	1883 x 394 x 50	1859 x 370	1740W	220V/16A



Coffee Pot 0.8L
50108011
SS304 156x80xH195 mm



Coffee Pot 0.5L
50105011
SS304 125x80x H157 mm



Tea Pot 0.8L
50108001
SS304 165x120xH135 mm



Tea Pot 0.5L
50105001
SS304 145x100xH110 mm



Milk Jug 0.25L
50102531
SS304 112.5x70x90 mm



Sugar Bowl 0.18L
50101821
SS304 83x83xH74.5 mm



Sugar Bowl
50106060
SS304 125x80x H157 mm



Sugar&Milk Plate
1508310
SS304 150x83xH10 mm



Tea Strainer
753000
SS304 Ø80xH40 mm



Condiment set



Coffee Pot 0.8L
50108011GR
SS304 156x80xH195 mm



Coffee Pot 0.5L
50105011GR
SS304 125x80x H157 mm



Milk Jug 0.25L
50102531GR
SS304 112.5x70xH90 mm



Sugar Bowl 0.18L
50101821 GR
SS304 83x83xH74.5 mm



Sugar Bowl 0.18L
50108011G
SS304 156x80xH 195 mm



Coffee Pot 0.5L
50105011G
SS304 125x80x H157 mm



Milk Jug 0.25L
50102531G
SS304 112.5x70xH90 mm



Sugar Bowl 0.18L
50101821G
SS304 83x83xH74.5 mm



Sugar Bowl 0.18L
50108011T
SS304 156x80xH 195 mm



Coffee Pot 0.5L
50105011T
SS304 125x80x H157 mm



Milk Jug 0.25L
50102531T
SS304 112.5x70xH90 mm



Sugar Bowl 0.18L
50101821T
SS304 83x83xH74.5 mm



Ice Water Jug 1.5L
WJ000150
SS304 L 145xH239 mm



Ice Water Jug 1.5L
50315051
SS304 145x120xH215 mm



Coffee & Tea Pot 0.50L
51305013
SS304 129x82xH174 mm



Coffee & Tea Pot 0.80L
51308013
SS304 140x95xH202 mm



Milk Jug 0.20L
51302031
SS304 64x60xH111 mm



Sugar Bowl 0.20L
51302024
SS304 76x76xH96 mm



Heat preservation effect from 95°C to 50°C after 12 Hours



Vacuum Jug 1.5L
8001500
SS304 165x125xH230 mm



Vacuum Jug 1.0L
800100
SS304 165x120xH215 mm



Vacuum Jug 0.65L
8000650
SS304 165x120xH190 mm



FLATWARE ROYAL 1608















3.5 MM 304 STAINLESS STEEL

The royal style with flower decorative design
Matching with exquisite manufacturing process
30 viewing of the visual



- SATIN FINISHED
- STONE FINISHED
- ROSE GOLD COLOUR
- TITAN COLOUR
- GOLD COLOUR

All of the Flatware can plated PVD Titan & Rose Gold & Gold Colour, or Silver Plated in 12 Micron 304 Stainless Steel, Mirror Polished

 Table Spoon 16080001 SS304 / 210mm	 Table Fork 16080002 SS304 / 205mm	 Table Knife 16080003 SS420J1 / 240mm	 Dessert Spoon 16080004 SS304 / 189mm
 Dessert Fork 16080005 SS304 / 192mm	 Dessert Knife 16080006 SS420J1 / 213mm	 Fish Fork 16080007 SS304 / 185mm	 Fish Knife 16080008 SS420J1 / 210mm
 Butter Knife 16080009 SS420J1 / 170mm	 Soup Spoon 16080010 SS304 / 177mm	 Cake Fork 16080011 SS304 / 151mm	 Tea Spoon 16080012 SS304 / 152mm
 Coffee Spoon 16080013 SS304 / 110mm	 Steak Knife 16080014 SS420J1 / 244mm		



FLATWARE AUERNBERG 8001















5.0 MM 304 STAINLESS STEEL

Drip style
More comfortable for user



- SATIN FINISHED
- STONE FINISHED
- ROSE GOLD COLOUR
- TITAN COLOUR
- GOLD COLOUR

All of the Flatware can plated PVD Titan & Rose Gold & Gold Colour, or Silver Plated in 12 Micron 304 Stainless Steel, Mirror Polished

 Table Spoon 80010001 SS304 / 210mm	 Table Fork 80010002 SS304 / 213mm	 Table Knife 80010003 SS420J1 / 240mm	 Dessert Spoon 80010004 SS304 / 189mm
 Dessert Fork 80010005 SS304 / 192mm	 Dessert Knife 80010006 SS420J1 / 213mm	 Fish Fork 80010007 SS304 / 192mm	 Fish Knife 80010008 SS420J1 / 204mm
 Butter Knife 80010009 SS420J1 / 170mm	 Soup Spoon 80010010 SS304 / 177mm	 Cake Fork 80010011 SS304 / 159mm	 Tea Spoon 80010012 SS304 / 134mm
 Coffee Spoon 80010013 SS304 / 110mm	 Steak Knife 80010014 SS420J1 / 244mm		



FLATWARE BANQUET 8004

4.0 MM 304 STAINLESS STEEL

Square handle design
with the perfect polishing effect
Strong metal feeling

- SATIN FINISHED
- STONE FINISHED
- ROSE GOLD COLOUR
- TITAN COLOUR
- GOLD COLOUR



All of the Flatware can plated PVD Titan & Rose Gold & Gold Colour, or Silver Plated in 12 Micron 304 Stainless Steel, Mirror Polished



Table Spoon
80040001
SS304 / 210mm



Table Fork
80040002
SS304 / 209mm



Table Knife
80040003
SS420J1 / 240mm



Dessert Spoon
80040004
SS304 / 185mm



Dessert Fork
80040005
SS304 / 184mm



Dessert Knife
80040006
SS420J1 / 210mm



Fish Fork
80040007
SS304 / 184mm



Fish Knife
80040008
SS420J1 / 207mm



Butter Knife
80040009
SS420J1 / 180mm



Soup Spoon
80040010
SS304 / 180mm



Cake Fork
80040011
SS304 / 156mm



Tea Spoon
80040012
SS304 / 152mm



Coffee Spoon
80040013
SS304 / 115mm



Steak Knife
80040014
SS420J1 / 240mm



FLATWARE CLASSIO 8005

4. 5 MM 304 STAINLESS STEEL

Germany Traditional style
With round handle design
Traditional and simple style

- SATIN FINISHED
- STONE FINISHED
- ROSE GOLD COLOUR
- TITAN COLOUR
- GOLD COLOUR



All of the Flatware can plated PVD Titan & Rose Gold & Gold Colour, or Silver Plated in 12 Micron 304 Stainless Steel, Mirror Polished



Table Spoon
80050001
SS304 / 200mm



Table Fork
80050002
SS304 / 199mm



Table Knife
80050003
SS420J1 / 240mm



Dessert Spoon
80050004
SS304 / 180mm



Dessert Fork
80050005
SS304 / 180mm



Dessert Knife
80050006
SS420J1 / 200mm



Fish Fork
80050007
SS304 / 183mm



Fish Knife
80050008
SS420J1 / 208mm



Butter Knife
80050009
SS420J1 / 170mm



Soup Spoon
80050010
SS304 / 176mm



Cake Fork
80050011
SS304 / 142mm



Tea Spoon
80050012
SS304 / 141mm



Coffee Spoon
80050013
SS304 / 110mm



Steak Knife
80050014
SS420J1 / 240mm

















**FLATWARE
ELEGANT 8006**

3.5 MM 304 STAINLESS STEEL
England style
With Arc slope handle
Traditional design

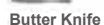

- SATIN FINISHED
- STONE FINISHED
- ROSE GOLD COLOUR
- TITAN COLOUR
- GOLD COLOUR

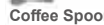
All of the Flatware can plated PVD Titan & Rose Gold & Gold Colour, or Silver Plated in 12 Micron 304 Stainless Steel, Mirror Polished

- | | | | |
|---|---|--|--|
| 
Table Spoon
80060001
SS304 / 210mm | 
Table Fork
80060002
SS304 / 205mm | 
Table Knife
80060003
SS420J1 / 240mm | 
Dessert Spoon
80060004
SS304 / 189mm |
| 
Dessert Fork
80060005
SS304 / 192mm | 
Dessert Knife
80060006
SS420J1 / 213mm | 
Fish Fork
80060007
SS304 / 185mm | 
Fish Knife
80060008
SS420J1 / 210mm |
| 
Butter Knife
80060009
SS420J1 / 170mm | 
Soup Spoon
80060010
SS304 / 177mm | 
Cake Fork
80060011
SS304 / 151mm | 
Tea Spoon
80060012
SS304 / 152mm |
| 
Coffee Spoon
80060013
SS304 / 110mm | 
Steak Knife
80060014
SS420J1 / 244mm | | |













**FLATWARE
MINI 1770**

4.0 MM 304 STAINLESS STEEL
Unique Lalin Style and with perfect shape of ladies' leg design
Elegant and Curvy
Suitable for special Restaurant

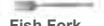

- SATIN FINISHED
- STONE FINISHED
- ROSE GOLD COLOUR
- TITAN COLOUR
- GOLD COLOUR

All of the Flatware can plated PVD Titan & Rose Gold & Gold Colour, or Silver Plated in 12 Micron 304 Stainless Steel, Mirror Polished

- | | | |
|---|--|---|
| 
Table Spoon
1770001
SS304 / 210mm | 
Table Fork
1770002
SS304 / 206mm | 
Table Knife
1770003
SS420J1 / 233mm |
| 
Dessert Spoon
1770004
SS304 / 182mm | 
Dessert Fork
1770005
SS304 / 181mm | 
Dessert Knife
1770006
SS420J1 / 205mm |
| 
Fish Fork
1770007
SS304 / 205mm | 
Fish Knife
1770008
SS420J1 / 212mm | 
Cake Fork
1770011
SS304 / 153mm |
| 
Tea Spoon
1770012
SS304 / 144mm | 
Coffee Spoon
1770013
SS304 / 123mm | |



FLATWARE VALE 4802

5.0 MM 304 STAINLESS STEEL
Simple design
Straight and simple
Slim and comfortable



- SATIN FINISHED
- STONE FINISHED
- ROSE GOLD COLOUR
- TITAN COLOUR
- GOLD COLOUR

All of the Flatware can plated PVD Titan & Rose Gold & Gold Colour, or Silver Plated in 12 Micron 304 Stainless Steel, Mirror Polished

 **Table Spoon**
48020001
SS304 / 205mm

 **Table Fork**
48020002
SS304 / 208mm

 **Table Knife**
48020003
SS420J1 / 240mm

 **Dessert Spoon**
48020004
SS304 / 180mm

 **Dessert Fork**
48020005
SS304 / 180mm

 **Dessert Knife**
48020006
SS420J1 / 210mm

 **Fish Fork**
48020007
SS304 / 182mm

 **Fish Knife**
48020008
SS420J1 / 205mm

 **Butter Knife**
48020009
SS420J1 / 171mm

 **Soup Spoon**
48020010
SS304 / 179mm

 **Cake Fork**
48020011
SS304 / 140mm

 **Tea Spoon**
48020012
SS304 / 140mm

 **Coffee Spoon**
11030013
SS304 / 110mm

 **Steak Knife**
11030014
SS420J1 / 240mm





JC009
509 x 304 x (H)8

JC005
535 x 330 x (H)80

JC003
535 x 330 x (H)85/170

JC002
535 x 330 x (H)80

JC018
509 x 139 x (H)8

JC013
535 x 165 x (H)40

JC011
535 x 165 x (H)80

MB001
480 x 325 x (H)48

MB002
480 x 325 x (H)43

XS031B
600 x 230 x (H)600

BASIC MODULE 1



JC001
535 x 330 x (H)80



JC002
535 x 330 x (H)80



JC003
535 x 330 x (H)85/170



JC004
535 x 330 x (H)40



JC005
535 x 330 x (H)80



JC006
509 x 304 x (H)8



JC007
509 x 304 x (H)8



JC008
509 x 304 x (H)8



JC009
509 x 304 x (H)8

BASIC MODULE 2



JC010
535 x 165 x (H)80



JC011
535 x 165 x (H)80



JC012
535 x 165 x (H)85/125



JC013
535 x 165 x (H)40



JC014
535 x 165 x (H)80



JC015
509 x 139 x (H)8



JC016
509 x 139 x (H)8



JC017
509 x 139 x (H)8



JC018
509 x 139 x (H)8

BASIC MODULE 3



JC019
330 x 270 x (H)80



JC020
330 x 270 x (H)80



JC021
330 x 270 x (H)85/125



JC022
330 x 270 x (H)40



JC023
330 x 270 x (H)80



JC024
304 x 244 x (H)8



JC025
304 x 244 x (H)8



JC026
304 x 244 x (H)8



JC027
304 x 244 x (H)8

BASIC MODULE 4



JC028
330 x 177 x (H)80



JC029
330 x 177 x (H)80



JC030
330 x 180 x (H)85/125



JC031
330 x 177 x (H)80



JC032
330 x 177 x (H)80



JC033
304 x 155 x (H)8



JC034
304 x 151 x (H)8



JC035
304 x 151 x (H)8



JC036
304 x 151 x (H)8



MB010
530 X 325 x (H)40
530 x 314 x (H)40/95



MB009
530 X 325 x (H)40
530 x 314 x (H)95/180



MB007
530 X 325 x (H)40
530 x 325 x (H)180



MB008
530 X 325 x (H)40
530 x 325 x (H)180



MB021
530 X 325 x (H)40
530 x 325 x (H)180



MB022
530 X 325 x (H)40
530 x 325 x (H)95/180



- 1 MB011A 110 x 100 x (H)250
- 2 MB011B 180 x 180 x (H)200
- 3 MB011C 220 x 220 x (H)350
- 4 MB011D 250 x 250 x (H)65
- 5 MB011E 400 x 250 x (H)65



MB017
574 x 250 x (H)432



MB018
309 x 323 x (H)441



MB019
574 x 250 x (H)857



MB013A (TWO LAYERS)
430 x 400 x (H)700

MB013B (THREE LAYERS)
336 x 450 x (H)800

MB013C (FIVE LAYERS)
550 x 550 x (H)1800



MB014
574 x 323 x (H)441



- 1 **MB016A**
305 x 390 x (H)90
- 2 **MB016B**
350 x 390 x (H)210
- 3 **MB016C**
390 x 390 x (H)330

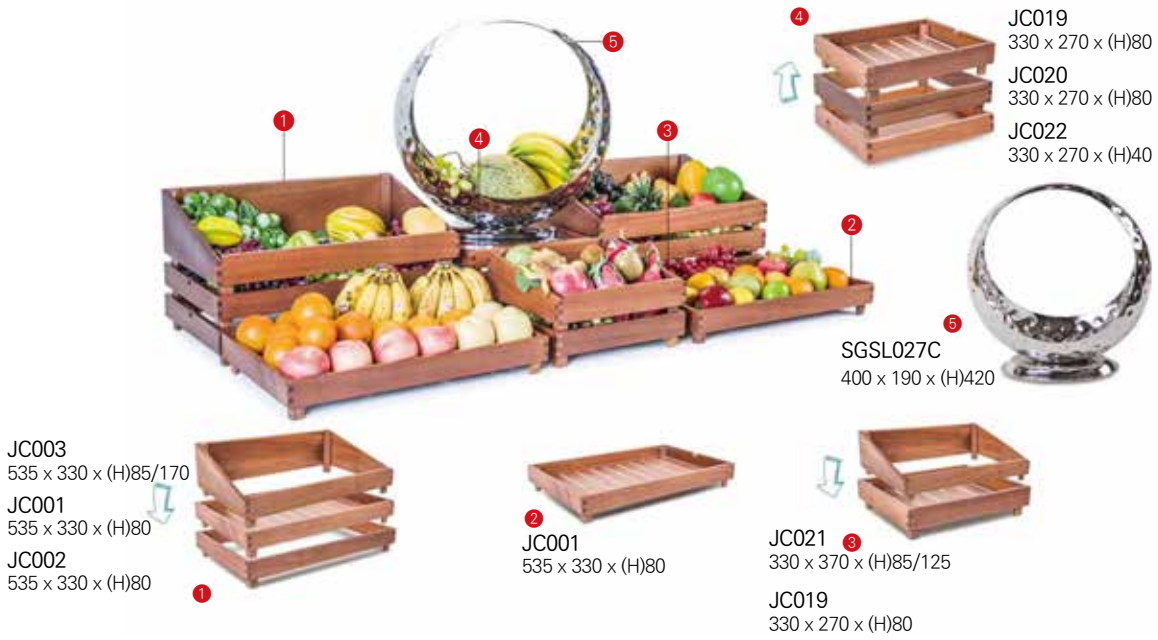

- ① SGSL013A
∅450 x (H)130
- ② SGSL013B
∅245 x (H)110
- ③ SGSL013C
∅180 x (H)85



- ① SGSL014A
∅450 x (H)130
- ② SGSL014B
∅245 x (H)110
- ③ SGSL014C
∅180 x (H)85



- ① SGSL015A
∅450 x (H)130
- ② SGSL015B
∅400 x (H)130
- ③ SGSL015C
∅330 x (H)130
- ④ SGSL015D
∅245 x (H)110
- ⑤ SGSL015E
∅180 x (H)85



SGSL047
∅400 x (H)200

SGSL048
∅300 x (H)200



SGSL049
∅270 x (H)135

SGSL050
∅200 x (H)135

SGSL051
∅150 x (H)95



HEIGHT SELECTION
(H)200 / 135 / 95

JC036
(L)304 x (W)151 x (H)8

JC030
(L)330 x (W)177 x (H)80

JC026
(L)304 x (W)244 x (H)8

JC020
(L)330 x (W)270 x (H)80

XS015
(L)800 x (W)260 x (H)10

Material options
 1 American Oak
 2 African Labeti wood

JC026
(L)304 x (W)244 x (H)8

JC020
(L)330 x (W)270 x (H)80



XS032
(L)300 x (W)100 x (H)20



XSDX001
(L)337 x (W)270 x (H)222



XS033
(L)200 x (W)200 x (H)20



XSDX002
(L)337 x (W)271 x (H)294



XS032
ø235 x (H)20



XSDX003
(L)544 x (W)330 x (H)325

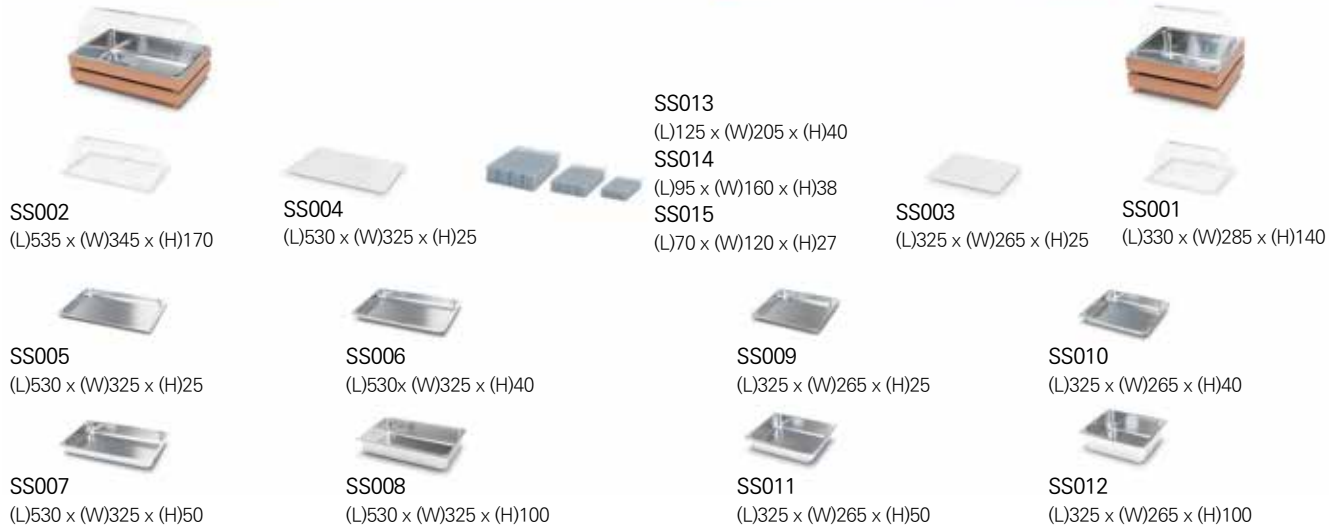

DESSERT DISPLAYS

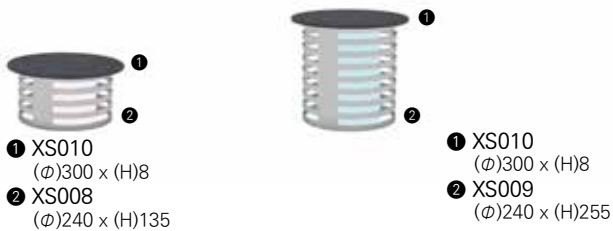
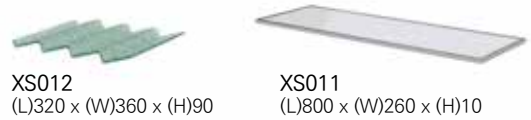

FERRIS WHEEL HIGH TEA STAND



XWC064
High Tea Stand
(L)587 x (W)200 x (H)630



THE LIGHTHOUSE HIGH TEA STAND



HKTK002A
High Tea Stand
(Φ)300 x (H)500
(Φ)400 x (H)670

HKTK003
High Tea Stand
(L)900 x (W)300 x (H)700



DOUBLE SAIL-SHAPED HIGH TEA STAND



CHRISTMAS TREE HIGH TEA STAND



XWC017
High Tea Stand
(Φ)385 x (H)625

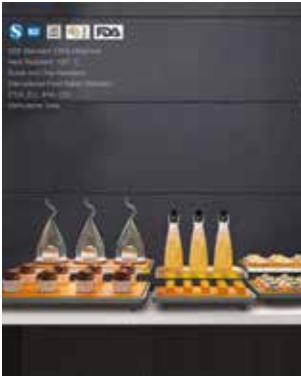

HOLDER XS047A
(L)555 x (W)350 x (H)50
(L)555 x (W)350 x (H)100



HOLDER XS048A
(L)350 x (W)290 x (H)50
(L)350 x (W)290 x (H)100



HOLDER XS049A
(L)350 x (W)200 x (H)50
(L)350 x (W)200 x (H)100

MELAMNE PLATE XS047B
(L)520 x (W)325 x (H)10

MELAMNE PLATE XS048B
(L)325 x (W)265 x (H)10

MELAMNE PLATE XS049B
(L)325 x (W)175 x (H)10



HOLDER XS050A
522 x 322 x H50
522 x 322 x H100

TRAY XS050B
522 x 322 x H40

SLATE XS050C
500 x 300 x H8



HOLDER XS051A
322 x 322 x H50
322 x 322 x H100

TRAY XS051B
322 x 322 x H40

SLATE XS051C
300 x 300 x H8



HOLDER XS052A
322 x 322 x H50
322 x 322 x H100

TRAY XS052B
322 x 322 x H40

SLATE XS052C
300 x 300 x H8



HOLDER XS053A
422 x 272 x H50
422 x 272 x H100

TRAY XS053B
422 x 272 x H40

SLATE XS053C
400 x 250 x H8



HOLDER XS054A
322 x 222 x H50
322 x 222 x H100

TRAY XS054B
322 x 222 x H40

SLATE XS054C
300 x 200 x H8



HOLDER XS055A
322 x 222 x H50
322 x 222 x H100

TRAY XS055B
322 x 222 x H40

SLATE XS055C
300 x 200 x H8



HOLDER XS056A
422 x 142 x H50
422 x 1422 x H100

TRAY XS056B
422 x 142 x H40

SLATE XS056C
400 x 120 x H8



HOLDER XS057A
4322 x 142 x H50
322 x 142 x H100

TRAY XS057B
322 x 142 x H40

SLATE XS057C
300 x 120 x H8



HOLDER XS058A
322 x 142 x H50
322 x 142 x H100

TRAY XS058B
322 x 142 x H40

SLATE XS058C
300 x 120 x H8



XWC059
Tea Stand- Egg Style
(Φ)320 x (H)400



XWC002C
Tea Stand
(L)344 x (W)241 x (H)360



XWC001A
Tea Stand
(L)350 x (W)270 x (H)420



XWC001B
Tea Stand
(L)350 x (W)270 x (H)420



XWC049A **XWC049B**
Tea Stand Tea Stand
(Φ)230 x (H)470 (Φ)176 x (H)294



XWC046
Tea Stand-Birdcage Style
(Φ)280 x (H)650



XWC047
Tea Stand-Birdcage Style
(Φ)280 x (H)650



XWC048
Tea Stand-Birdcage Style
(Φ)280 x (H)620



XWC060
Tea Stand
(L)300 x (W)160 x (H)450



Glossy Acrylic Layer
(L)225 x (W)100 x (H)5

Marbling Layer
(L)225 x (W)100 x (H)5

Layer Carved with Designs
(L)225 x (W)100 x (H)5



DCS XWC056
Hot-Air Balloon High Tea Stand
(L)350 x (W)280 x (H)500





BX008
Cold Display
(L)1200x 400 x (H)200/250



BX009
Cold Display
(Φ)470 x (H)200



BX003
Cold Display
(Φ)410 x (H)250



BX010
Cold Display
(L)600 x (W)400 x (H)200/250



BX011
Cold Display
(L)400 x (W)400 x (H)200



BX004
Cold Display
(L)535 x (W)330 x (H)250



BX039A
Cold Display
(L)3700 x (W)850 x (H)350



BX039B
Cold Display
(L)4300 x (W)690 x (H)350



BX040
Cold Display
(L)4500 x (W)800 x (H)650



BX012
Ice Bucket
(Φ)430 x (H)200



BX013
Ice Bucket
(Φ)330 x (H)160



BX014
Ice Bucket
(Φ)340 x (H)290



BX016
Ice Bucket
(Φ)250 x (H)250



BX015
Ice Bucket
(Φ)340 x (H)315



BX041
(L)585 x (W)295 x (H)255

Projects

● Hotel

롯데호텔 / 시그니엘호텔 / L7	베스트웨스턴 세종
JW메리어트호텔 서울, 동대문	인터불고 호텔
그랜드엠버서더 풀만	세종호텔
그랜드하얏트 서울, 인천, 제주	유성호텔
파크하얏트 서울, 부산	라한호텔 포항 / 전주 / 경주 / 목포
노보텔엠버서더호텔	코모도 호텔
인스파이어리조트	보코 서울 강남 / 명동
파르나스호텔 (그랜드 인터콘티넨탈 등)	쉐라톤호텔 인천
신라호텔 / 신라스테이	인터시티 호텔
조선호텔 / 조선팰리스 / 그랜드조선	코트야드메리어트 수원 / 타임스퀘어 / 남대문 / 평택 / 세종
포시즌스호텔	윈덤그랜드 부산
콘래드호텔	알펜시아 호텔
페어몬트호텔	라마다프라자 여수
더케이호텔	유탑호텔
몬드리안호텔	대구메리어트
위커히호텔	오크우드호텔 코엑스 / 송도
포포인츠 바이 쉐라톤 강남/수원/구로/명동	경원재엠버서더
소피텔 엠버서더	엘타워
머큐어 마곡	이비스엠버서더 인천공항
웰파크시티호텔	신라모노그램
더블트리 바이 힐튼 서울 판교	제주신화역사공원





● Convention

코엑스 서울 / 마곡

대구 엑스코

창원컨벤션

안동컨벤션

오송컨벤션

● Resort

한화리조트

롯데리조트

금호리조트

대명리조트

리솜리조트

켄싱턴리조트

● 단체급식

SPC

본푸드

CJ 프레시웨이

아워홈

휴먼푸드

웰스토리

● 체인점

채선당

아펠가모

쿠우쿠우

그린플레이트

미스터피자



고객을 위한 창조와 봉사,
바로 우리의 사명입니다.



경기도 광주시 오포읍 마루들길 259-12

TEL : 031-766-3773

FAX : 031-762-3079

www.daewoncns.com

e_mail : daewoncns7@daum.net

본 카탈로그에 실린 내용물은 더 좋은 제품개발을 위해 예고없이 변경될 수 있습니다.
본 카탈로그의 칼라와 소재는 실제색상과 다소 차이가 있을 수 있습니다.



경기도 광주시 오포읍 마루들길 259-12

TEL : 031-766-3773

FAX : 031-762-3079

www.daewoncns.com

e_mail : daewoncns7@daum.net